

Energetic Cost of Running With and Without the Ball in Male Basketball Players

Altavilla, Gaetano

Doctoral thesis / Disertacija

2021

Degree Grantor / Ustanova koja je dodijelila akademski / stručni stupanj: **University of Split, Faculty of Kinesiology / Sveučilište u Splitu, Kineziološki fakultet**

Permanent link / Trajna poveznica: <https://um.nsk.hr/um:nbn:hr:221:744027>

Rights / Prava: [In copyright](#) / [Zaštićeno autorskim pravom.](#)

Download date / Datum preuzimanja: **2024-08-31**



Repository / Repozitorij:

[Repository of Faculty of Kinesiology, University of Split](#)



UNIVERSITY OF SPLIT
FACULTY OF KINESIOLOGY

GAETANO ALTAVILLA

**ENERGETIC COST OF RUNNING WITH AND WITHOUT
THE BALL IN MALE BASKETBALL PLAYERS**

DOCTORAL THESIS

MENTOR: Full Professor MARIO JELIČIĆ PhD

CO-MENTOR: Associate Professor GAETANO RAIOLA PhD

Split, 2021

Dana 21. siječnja 2021. godine Gaetano Altavilla je **obranio** je doktorsku disertaciju pod naslovom:

“ENERGETIC COST OF RUNNING WITH AND WITHOUT THE BALL IN MALE BASKETBALL PLAYERS”

pod mentorstvom dr.sc. Mario Jeličić, redovitog profesora Kineziološkog fakulteta u Splitu i sumentorstvom dr.sc. Gaetano Raiola, izvanrednog profesora Sveučilišta u Salerno

javnom obranom pred Stručnim povjerenstvom u sastavu:

1. dr.sc. Vladimir Ivančev, izvanredni profesor Kineziološkog fakulteta u Splitu, predsjednik
2. dr.sc. Marko Erceg, izvanredni profesor Kineziološkog fakulteta u Splitu, član
3. dr.sc. Miran Pehar, docent Fakulteta prirodoslovno-matematičkih i odgojnih znanosti Sveučilišta u Mostaru, član
4. dr.sc. Miodrag Spasić, docent Kineziološkog fakulteta u Splitu , član
5. dr.sc. Goran Gabrilo, izvanredni profesor Kineziološkog fakulteta u Splitu, član

Pozitivno izvješće Povjerenstva za ocjenu doktorske disertacije prihvaćeno na sjednici Fakultetskog vijeća održanoj dana 23. prosinca 2020. godine.

Acknowledgment

My appreciation and deepest gratitude for the helping and supporting are extended to the following people who in different ways have contributed in making this doctoral thesis possible.

To Prof. Gaetano Raiola for being my co-mentor in writing the doctoral thesis and for teaching me a lot, over the years, and for the activities carried out in the research group of the "Laboratory of Methods and didactics of sports activities" at the University of Salerno, Italy.

To Prof. Ivana Bavcevic for being a valuable professional and friendly presence during the three years of the doctorate and for making the interaction and stay in Split pleasant.

To all the professors of the PhD of the Faculty of Kinesiology of Split (Croatia), for their professional depth, in presence and in e-learning. In the same way, I say thank you to the administration office for the availability and for the precise reply to our doubts.

To all my PhD colleagues with which we had a continuous and active collaborations, for the days spent together in Split and on the phone, for the support and discussion that has never been missing, in particular a thanks to my room and travel mates Giuseppe Penna and Lorenzo Riela.

To Prof. Andrea D'Alterio for giving me the possibility of conducting the research activity with the players of his teams ASD Giugliano, Naples (Italy).

To Prof. Biagio Simonetti for having welcomed me in his study at the University of Sannio, Benevento (Italy), directing me and advising me on the different applications of statistical models, thanks to him it has been possible to realize various processes of elaboration.

A special thanks goes to Prof. Mario Jeličić for having accepted to be my mentor for this doctoral thesis, and for offering me his valid professionalism, experience and human support.

Finally, my family has taught me perseverance and helped me remain focused throughout my academic duties and for that, and their unconditional love, I will always be grateful.

Summary

Acknowledgment	2
Abstract	7
1. Introduction	9
1.1 Research problem	14
1.2 Research aim and hypothesis	16
1.3 Expected scientific contribution of the proposed research	17
2. ENERGETIC COST IN THE DIFFERENT RUNNING CONDITIONS	18
2.1 Historical references on energetic cost	20
2.2 Energetic cost of the running	22
2.3 Running Biomechanics	24
3. METHODS	26
3.1 Experimental approach	28
3.2 Yo-Yo EnduranceTest	36
3.3 Shuttle and linear running	40
3.4 Lower limbs muscle strength	41
3.5 Statistical analysis	43
4. DEVICES	44
4.1 Metabolimeter K4b2.....	46
4.2 Optojump	48
4.3 Ratings of perceived exertion (RPE)	50

4.4	Global Navigation Satellite System with inertial measurement unit (GNSS-IMU)	55
5.	RESULTS	
5.1	Anthropometric and physiological characteristics	57
5.2	Energetic cost of running at six different conditions	59
5.3	ICC for the reliability of the measures	62
5.4	Lower limbs strength	63
5.5	Values of RPE for each running condition	76
6.	DISCUSSION	
6.1	Energetic cost in the running conditions and between the two groups	79
6.2	Reliability of the measures (ICC)	81
6.3	Lower limbs strength (pre and post)	83
6.4	RPE for each running condition and its utility	85
7.	CONCLUSION	87
8.	PRACTICAL APPLICATIONS	89
9	REFERENCES	90

Sažetak

Cilj istraživanja bio je procijeniti potrošnju energije pri različitim uvjetima trčanja sa i bez lopte (1000m na 80% VO₂max) koristeći pritom linearno trčanje, *shuttle* trčanje (180°) te linerano stani/kreni trčanje. Istraživanje je provedeno na dvije skupine igrača podijeljene s obzirom na pozicije u igri (bekovi: n = 15; krila/centri: n = 15). Eksperimentalni je pristup zahtijevao upotrebu sljedećih testova/uređaja: prijenosni metabolimeter korišten je za procjenu VO₂max za svaki tip trčanja, skok iz čučnja (OptoJump) za procjenu razlike jakosti donjih ekstremiteta prije i nakon svakog testa te je provedena subjektivna procjena umora nakon svakog tipa trčanja u svrhu procjene trenažnog opterećenja. Globalni navigacijski satelitski sustav korišten je za procjenu nagiba tijela te ubrzanja i usporevanja pri svakoj vrsti trčanja. Korišten je T-test za nezavisne uzorke i dvosmjerna analiza varijance ANOVA za određivanje značajnih razlika za svaku varijablu i u svim uvjetima trčanja. Rezultati ovog istraživanja mogli bi biti korisni za optimizaciju opterećenja tijekom košarkaškog treninga vezanog uz uvjete trčanja u različitim sezonama te za optimizaciju opterećenja u odnosu na pozicije i energetske kapacitete igrača.

Ključne riječi: uvjeti trčanja, potrošnja energije, smanjenje snage, izvedba

Abstract

This study aimed to assess the energetic cost (C) at different running conditions (RC) with/without the ball (1000m at 80% of VO₂max) during: Linear running, Shuttle running (180°), Linear running with stop and restart, between two groups according to the position/role (guards: n=15; forwards/centres: n=15). Experimental approach to the problem required the following tests/devices: a portable metabolimeter was used to assess the metabolic parameters for each RC, Squat Jump (OptoJump) to assess the strength's decrease difference of the lower limbs before/after each test and Ratings of Perceived Exertion (RPE) after each RC to assess the training load, while the Global Navigation Satellite System (GNSS-IMU) was used to assess the body inclinations and Acceleration/Deceleration for each RC. The T-test was used for independent samples and Two-way repeated measures ANOVA was used to assess the significant differences for each variable between each RC. The results of this study could be useful not only for coaches to optimize basketball training load related to the RC (with and without the ball), but also to optimize the motor learning in young basketball players and to optimize the load of work in relation to the position and energetic capacities of players.

Key words: running conditions, energy expenditure, strength, performance

1. Introduction

Basketball is characterized by a multiple high-intensity actions (Sanchez et al, 2018) performed while changing direction. It represents a multi-task sport, defined on the basis of several active/passive phases as it is very hard to replicate during the training (Altavilla & Raiola, 2015). Indeed, in the basketball game situations change quickly and frequently (Altavilla & Raiola, 2014) as a function of the following factors:

- the position of the opponents on the field and their tactical behavior, making defensive and offensive choices (Oliveira et al, 2018);
- the players position in the pitch area and their movements, making defensive and offensive choices (Nikolaidis et al, 2015);
- in relation to the position of the ball related to active phases, making defensive and offensive choices games (Altavilla & Raiola, 2014).

In addition, regarding bioenergetics in basketball it was considered crucial (Ben Abdelkrim et al, 2010a) since metabolic demands under stress can negatively alter player's performance (Bompa & Haff, 2009).

Moreover, the basketball is an intermittent high-intensity physical activity that requires an aerobic (Scanlan et al., 2021) and anaerobic well-developed energetic mechanism (Hoffman & Maresh, 2000) and it is featured from activity of short time at high intensity (Castagna et al, 2008); as well as others team's sport (i.e.: soccer, rugby, handball) are generally considered sports characterized by multiple high-intensity activities interspersed with low-intensity activities (Da Cruz-Ferreira & Ribeiro, 2013; Argus et al, 2012).

The match analysis showed that basketball players, during a match, while sprinting, with and without changes in direction (Schot et al, 1995), at different velocities (Ben Abdelkrim et al., 2007), over short distances (10<20m) and within a

limited timeframe (Crisafulli et al., 2002) of up to 20 sec. (Narazaki et al., 2009) these movements determines considerable metabolic demands (Ben Abdelkrim et al, 2010b; McInnes et al, 1995).

These actions represent a variety of multidirectional movements (Jeličić et al, 2020) such as jumping, running, dribbling, sprinting, stopping and restarting performed at different speeds and intensities (Klusemann et al, 2013; Ben Abdelkrim et al, 2007).

During a match numerous short sprints might occur in successive different directions (Ben Abdelkrim et al, 2007), e.g., during offense, when a basketball player moves from outside the three-point line toward the low post and back to the three-point line, and then moves laterally outside the three-point line or during man-to-man defense when a defender follows offender's actions.

A basketball team performs around 90 offences (Dežman, 2003) and most of them consist of phases of fast transition from defense to offence and often also a quick counter-attack.

Typically, running in team sports (Altavilla, 2020) has biomechanical characteristics and different energetic costs with respect to linear running. Moreover, types of run change according to physical characteristics (Altavilla & Raiola, 2019) and physiological effort (Scanlan et al, 2011).

Basketball players, thus, must have a high capability to move quickly, and jump and bounce the ball, coordinating at the same time movements of the lower and upper limbs (Cortis et al., 2011) and, in order to achieve and to evaluate efficient performances, it is important to understand fatigue-related body adaptations and compensations.

Therefore, they must be able to effectively perform specific tasks under conditions of physical fatigue that occur during different training and game intensity (Kamandulis et al., 2013).

Team sports such as basketball present multiple and different dynamics during the game as a result of variability in offensive and defensive plays (Bourbousson et al, 2010).

These requests justify a specific training method such as team sports (basketball, soccer, rugby), in which typical running is characterized by acceleration and deceleration phases, which entails a greater energy expenditure (di Prampero et al, 2014).

The energetic expenditure such as the metabolic power (Polglaze et al, 2018) seems to be useful in team sports to balance the external load (running conditions) compared to the internal training load; therefore, for these reasons, the workload analysis during a competition is crucial today to optimize the training program (Altavilla & Raiola, 2018).

Several studies on the physiological load of these activities are generally limited to the overall load, combining various types of displacements without assessing each one individually (Bangsbo, 1994; Montgomery et al, 2010; Narazaki et al, 2009). However, others studies attempted to tackle this problem using different approaches (Dellal et al, 2010; di Prampero et al, 2005; Lothian & Farally,1995).

For instance, Bisciotti et al. (2000) attempted to quantify the difference in energetic cost between linear run and with changes of directions at the same speed and estimated that the amount of energy expended is proportional to the number of acceleration and deceleration.

A few years later, di Prampero et al. (2005) developed algorithms that were recently used by Osgnach et al. (2010) to estimate the energetic cost of acceleration and deceleration to measure the energy expenditure.

Dellal et al. (2010) quantified the physiological effect of directional changes in soccer by comparing in-line running and shuttle running during fitness training sessions. Few studies looking at the physiological load of acceleration and

deceleration during directional changes of a shuttle running with the ball and without the ball.

None of the studies measured the energetic cost associated to different running conditions, taken into consideration in this research with the aim to assess the energetic cost of running with and without the ball: linear running, shuttle running with changes in direction at 180°, linear running with stop and restart running every 15 m.

More specifically, none of the studies investigated the energetic cost difference between different running conditions, with and without directional changes, with and without the ball and between two groups of players divided according to their position/role.

Also if, the training load in team sport was well investigated (Bartlett et al, 2017), lack again informations on energetic cost related to the start, stop and restart running in literature; for which it is necessary to investigate and to assess the energy cost of the running in different conditions.

Therefore, investigation of the running conditions can to contribute:

- a) to improvement of the learning mechanism process about the different running conditions;
- b) learning the levels of energy expenditure under different running conditions with and without the ball;
- c) optimizing the motor learning based on a specific motor task in young players;
- d) acknowledging different running metabolic demand to optimize the training load in different seasonal periods aiming for high sport performances.

Finally, studying the several types of runs with different tasks is useful to understand how the energetic cost change due to the complexity of the task performed (with and without the ball). Indeed, when the subject runs, changing

direction and controlling the ball, he has an effort and a greater motor control, both in terms of bioenergetic and biomechanical.

This allows us to set up specific paths of training to improve the motor learning, making this more economic and efficient; and it suggest us possible investigations on other aspects of the performance, of motor learning and of the teaching methodology.

1.1 Research problem

Basketball players cover 4500<5000m during a 40 minutes game with multidirectional actions; such as, sprint with and without changes of direction and running at different speeds (Ben Abdelkrim et al., 2007).

In the last decade, the energetic expenditure such as the metabolic power (Polglaze et al, 2018) seems to be useful in team sport to balance the external load (different running conditions) compared to the internal training load.

While there is some investigation on training load in team sport (Bartlett et al, 2017), there is a lack of information on energetic cost related to the running conditions.

Moreover, few studies examined the type of runnings showing the different physiological demand of the players (Narazaki et al, 2009, Montgomery et al, 2010, Puente et al, 2017) but without investigating the slowdown/starting phases and/or with/without the ball to better replicate the basketball match conditions.

Indeed, in the last years, some researchers have focused mainly on the shuttle run with different changes of direction (Zamparo et al, 2014; Bekraoui et al, 2018), but little attention has been paid on the run with stop and restart (with and without the ball) without changes of direction.

The fractional running represents the ecological approach to replicate the basketball match; for example, when the player with the ball makes a change of speed to free himself from the opponent or to simulate a long sprint while he stops running to throw the ball.

Therefore, the knowledge of the different running's metabolic demand is useful for basketball players to optimize the training load in different seasonal periods based on different running conditions and positions.

1.2 Research aim and hypothesis

The aim of this study is to assess the energetic cost of running in different conditions (1000 m at 80% of $VO_2\text{max}$) with and without the ball: Linear running (LR), Shuttle running with change in direction at 180° (SR), Linear running with stop and restart (LR&SR) running every 15m between two groups (Guards and Forwards/Centres).

I think that the metabolic expenditure should be different in all six running conditions (i.e., on the specific task) and between the two groups (Guards and Forwards/Centres).

My hypothesis that the energetic cost (C) could increase during running with the ball compared to running without the ball, independently of changes in direction. This could be justified by conditioning of motor control to synchronize dribble during running gait of the players. However, the running gait energy consumption with linear running with stop and restart (LR&SR) every 15m (without the ball) could be increased by the deceleration/acceleration of the player on the frontal plane, compared to changes in direction (180°); in fact, player's body stabilization needs more mechanical work.

1.3 Expected scientific contribution of the proposed research

All these different running conditions that regularly occur in sports such as basketball, soccer, rugby and handball, show the importance of this issue. Of course, I expect obvious differences between those kinds of running, but we do not know the magnitude of those differences, and I do not know how the displacement speed affects these differences.

This is important not only to better understand the physiological requirements of sports activities with frequent changes of direction, but also to better perceive the differences between using VO_2 consumption or HR monitoring in quantifying workloads during such activities.

I expected that the energetic cost (C) is dependent on type of running and high in the running with ball; conversely, the energetic cost (C) will be lower without the ball for each running conditions.

The results of this study could be useful to:

1) Coaches to program specific training on the different running conditions (with and without ball) optimize the training load based on changes of direction running vs. linear running;

2) to optimize the training load with the ball in order to improve both physiological effort and motor control in young basketball players.

2. Energetic cost in the different running conditions

The human is the first economic system to provide a locomotion gait: how a car consumes some liters of petrol to cover certain kilometers, so also man also needs a quantity of energy to cover a relative distance.

The energetic cost (C), as in the car, indicates the liters consumed (for example 20 km with 1 liter of fuel), in the same way in the human the energetic cost (C) indicates the energy needed to cover a distance (m or km) and can be expressed in: Joules (J), kiloJoule (kJ), calories (cal), kilocalories (kcal), watts (w), kilowatts (kw), liters or milliliters of oxygen (L or ml of O₂). To be able to convert one unit of measurement into another, it is enough to remember that in the human body 1 L of O₂ consumed develops 5 kcal or 21 kJ.

Normally C is expressed net, that is above the rest value, because if, instead of covering a certain distance at the same time, the subject had remained in resting position, he would have consumed, however, a quantity of energy needed to its vital functions. In fact, like a car, stopped in place, with the engine running, it consumes a minimum amount of fuel, which allows the engine to idle, without turning off, so even the human being, at rest, needs a minimum quantity of energy, which allows him to live.

The energetics of human locomotion quantitatively describes the energy expenditure (Hall et al, 2004) of humans in motion or at rest. C represents the amount of energy needed to cover a unit distance and is generally expressed in kJ·km⁻¹ or J·m⁻¹ or in values related to the body weight kJ·km⁻¹·kg⁻¹ or J·m⁻¹·Kg⁻¹.

The energy expenditure per unit of time, defined metabolic power \dot{E} , is given by the product of energy cost (C) for speed (by Prampero, 1986):

$\dot{E} = C \cdot v$, from this equation for a simple transposition of terms we get:

$$v = \dot{E}/C.$$

\dot{E} will result in kW, when C is expressed in $\text{kJ}\cdot\text{km}^{-1}$ and v in $\text{km}\cdot\text{s}^{-1}$ instead

\dot{E} will result in $\text{kcal}\cdot\text{h}^{-1}$, when C is expressed $\text{kcal}\cdot\text{km}^{-1}$ and v in $\text{km}\cdot\text{h}^{-1}$.

The maximum speed (v^{max}) of every form of human locomotion is given by the ratio between the maximum metabolic power (\dot{E}^{max}) of the subject divided by the energy cost of the locomotion in question, which, in turn, is a function of speed:

$$v^{\text{max}} = \dot{E}^{\text{max}}/C.$$

2.1 Historical references on energetic cost

In the second half of the 19th century, Smith (1859), Gruber (1891), Sonden and Tigersted (1895) measured the energetic cost of walking on level ground at different speeds between 3.2 and 4.8 km·h⁻¹. The values reported from these authors was between 0.32 and 0.52 kcal·kg⁻¹·km⁻¹, and surprisingly they are close to those currently measured.

At the beginning of the 20th century, Bresina and Kolmer (1912) and Bresina and Reichel (1914) established that the energetic cost of the walking, per kilogram of weight transported and units of distance, very clearly increases to about 4.8 km·h⁻¹.

Kantzenstein (1891), Schumburg and Zuntz (1896), and Loewy et al. (1897) investigated the energetic cost of the uphill walk and calculated the efficiency of the energy potential of metabolic exchanges, obtaining values between 20% and 37%.

Galeotti and Others (1914) determined the energetic cost of the walk at altitude (2900m) at the laboratory “A. Mosso” on Monte Rosa. The values obtained are between 0.37 and 0.55 kcal·kg⁻¹·km⁻¹ and are similar to those measured by other authors, at sea level.

The first studies carried out on the energetic cost of the walking were carried out by Margaria in 1938 at speeds between 0.5 and 9.5 km⁻¹·h⁻¹ and a gradient of between + 40 and - 40% (of Prampero, 1986).

Cavagna and Coll. (1983) showed that for every inclination there is an optimal speed, which is reduced with decreasing height, to which the energetic cost is minimal. At speeds between 0.69 and 2.08 m·s⁻¹, the energetic cost is minimal at the speed corresponding to the frequency of the step chosen spontaneously by the subject (Minetti et al, 1995). The same authors confirmed

the data of Margaria (1963), according to which the cheapest slope both uphill and downhill is around 25%.

Menier and Pugh (1968) indicate that the energetic cost of the competitive march, for speeds above $2 \text{ m}\cdot\text{s}^{-1}$, is lower than that of the ordinary march. However, at maximum reachable speed, around $4 \text{ m}\cdot\text{s}^{-1}$, the energetic cost of competitive walking is 20% higher than that of the running at the same speed (Osgnach et al, 2010).

2.2 Energetic cost of the running

Energetic cost of the running was determined by Waller (1919) and Liljestrand in Stenström (1919), reporting values between 0.8 and 1.3 kcal·kg⁻¹·km⁻¹, which are not very far from those currently accepted.

An in-depth study on the energetic cost of the running, as well as on the way, was carried out by Margaria in 1938 at speeds between 6.5 and 15 km·h⁻¹ and a gradient between + 5 and - 30%.

Energetic cost of the running (Cr), according to some prestigious authors, is independent of the speed of running, up to speeds of 22 km·h⁻¹, and can be considered constant and of the order of 3.8 kJ per kg and per km of path (0.9 kcal⁻¹·kg⁻¹·km⁻¹) Margaria and Others (1963), by Prampero (1986, 2002).

Since 1956, Åstrand noted that the energetic cost variations in running are fairly small among adults, and oxygen consumption per kg (body weight) is similar regardless of gender and athletic level. Fox and Costill (1972) reported that the energetic cost of middle-distance runners is 5-10% higher than that of marathon runners, evaluations were made on the best athletes of the time in the two specialties.

The differences of Cr per kg of weight and meter running, in excellent runners, are very small, Margaria and Others (1975); in well-trained athletes, who run at 20 km·h⁻¹ on the flat varies only between 67 and 71 ml⁻¹·min⁻¹·kg⁻¹. The intersubjective variability of the energetic cost of walking and running, in adult subjects, when Cr is expressed per kg of body mass, is very small, of the order of ±5% (by Prampero & Veicteinas, 2002).

This is probably due to the fact that the nervous mechanisms of control of the march and of the running, natural locomotions par excellence, leave very little margin for possible acquired modifications. In fact, even in athletes of great

experience and excellent performance, the energy cost of the running does not go far from the average values observed in sedentary subjects (by Prampero & Veicteinas, 2002).

In the 1980s, the 20m shuttle test was designed and validated, Léger et al. (1982, 1988, 1989), later, Bangsbo elaborated the original test, reaching, in 1994, the elaboration of three versions of the Yo-Yo test: Endurance, Intermittent and Intermittent Recovery (Bangsbo, 1994,1996).

The three test versions, recently are widely used in team sports to assess the aerobic condition of the players; their diffusion is due to the type of running used during the evaluation tests, which turns out to be more specific in sports in which many changes of direction occur during the performance, and therefore the continuous running, performed in line, turns out to be a little specific element.

2.3 Running biomechanics

There are two main ways that exercise physiologists assess a runner's ability: $VO_2\text{max}$ and economy. In everyday activities, the body takes in oxygen which is used to aerobically produce ATP, the form of energy used within the body. When exercising the amount of ATP and thus the amount of oxygen required by the body increases. The maximum amount of oxygen that a person can take up and use to meet the aerobic energetic demands is called the $VO_2\text{max}$.

They can vary greatly between people and is a fairly good predictor of aerobic running performance. The athletes can take up larger amounts of oxygen and, then, produce more ATP, allowing them to maintain a challenging running pace for longer than those with a small $VO_2\text{max}$ (Foster et al.,1978).

To have a high $VO_2\text{max}$ is a factor which can be developed; for example, if untrained individuals start a running program, they can improve their $VO_2\text{max}$ (Daniels et al.,1978). In the trained subjects the $VO_2\text{max}$ is relatively stable, meaning that each runner has a limit beyond which $VO_2\text{max}$ can no longer be increased (Daniels et al., 1978).

However, even once this $VO_2\text{max}$ limit is reached, trained individuals can continue to improve their running performance, indicating that $VO_2\text{max}$ is not the only factor that determines running ability. Another contributing factor to a runner's ability is running economy (Lucia et al, 2006).

Running economy is defined as the rate of oxygen uptake of an individual running at a standardized velocity (Conley et al., 1980).

Those that take up less oxygen when running at a certain speed are considered more economical than others. Essentially, because oxygen uptake is directly related to ATP production, economical runners are good at conserving energy, so they can run at fast paces at a lower energetic cost than un-economical runners can.

As with $VO_2\text{max}$, running economy can be improved; trained runners are generally more economical than untrained runners (Morgan et al. 1995). Although being economical allows runners to save energy, ultimately, the ideal runner would have both a high $VO_2\text{max}$ and excellent economy (Williams & Cavanagh, 1987).

3. Methods

The sample of subjects (90%) included young male basketball players ($n=30$) aged 18 ± 1 . Subjects ($n=30$) were divided in two groups of 15 according to position/role (guards: $n=15$; forwards/centres: $n=15$).

The players were members of the ASD Basket Club Giugliano, Naples (Italy) and they had at least five years of training experience and participated at the Italian Basketball Championship (Category: Under 18). Players participated voluntarily in this investigation.

The inclusion criteria considered for young basketball players was five years of training experience; whereas the exclusion criteria was no history of injuries in the last year (i.e. muscles, tendons, bones).

The variables investigated were:

- Maximum oxygen consumption ($ml \cdot kg \cdot min^{-1}$)
- Mean and Maximum heart rate (b/min)
- Jump performance (cm)
- Ratings of Perceived Exertion (RPE)
- Mechanical work ($j \cdot (kg \cdot m)^{-1}$)

The method of detection and analysis of data required the use of following tests and devices:

- Yo-Yo endurance test (Bangsbo et al., 2006);
- Shuttle running and linear running (Zamparo et al, 2014; Vaquera et al, 2016), assessed with Metabolimeter K4b2 (Cosmed, Italy);
- Lower limbs muscle strength (Bosco et al, 1983) assessed with Optojump (Microgate, Italy);
- Ratings of Perceived Exertion (Cr 0<10; Impellizzeri et al, 2004);
- GNSS-IMU (SpinItalia, Italy) to assess the body inclinations and Accelerations/Decelerations for each running conditions.

3.1 Experimental approach

Participants were provided with written and oral explanations of the protocol and of the experimental scheme.

The study included 7 testing sessions over a 10-day period with a minimum of 3-day rest in-between (Table 1).

In the first session (Sunday), the participants did an indirect continuous multistage field test (Leger & Boucher, 1980) to determine $VO_2\text{max}$ to set the relative intensities of the next 6 experimental sessions.

Randomly performed, these sessions were: (a) in-line continuous running (LR), (b) Shuttle running (SR) with directional changes (180°) every 15m and (c) Linear running (LR&SR) with stop and restart every 15m in the same direction.

For each protocol, participants were required to run at an imposed intensity at 80% of $VO_2\text{max}$.

Table 1. Timetable of testing sessions over a 10-day period

Sun	Mon	Tue	Wed	Thu	Fri	Sat	Sun	Mon	Tue
Yo-yo Test (is done only this time)	Rest	LR without ball (all day)	LR with ball (all day)	Rest	SR without ball (all day)	SR with ball (all day)	Rest	LR&SR without ball (all day)	LR&SR with ball (all day)

Beep sounds and track markers were used as spatiotemporal references to pace the subject. Beep sounds were emitted with a homemade programmable sound generator.

All participants easily kept the pace within less than 1m from the track marker at each beep and in relation to heart rate, detected by a frequency meter.

All the tests were conducted on a flat 100m course on a synthetic rubber surface.

The testing scheme and protocols are presented in the Figures 1, 2, 3 and 4.

Before each test, participants performed 10 minutes of a warm-up, including 5 minutes of dynamic stretching.

Seven testing sessions were included in the study over a ten-days period with three days of rest in-between.

After one week all tests were repeated to assess the reliability of measurements.

The Yo-Yo endurance test (typical for team sports) has been performed by each player, as an incremental test according to di Prampero (2009) to detect the VO_2max .

After the VO_2max test, for each running condition, the Squat Jump (SJ) was performed to verify the muscle strength decrement according to the Bosco's (1983) procedures.

Following, players were tested (speed: 1000m at 80% of VO_2max , previously measured; corresponding at 5/6 minutes, useful to reach a steady state oxygen consumption), players were randomly selected (one-to-one) in 6 groups.

Each group has been randomly evaluated in six running conditions (1000m at 80% of VO_2 max with and without the ball: linear running (LR), linear running with stop and restart every 15m (LR&SR) and shuttle running (SR) with change in direction (180°).

A) Linear running

The path LR (Figure 2) foresees that the players must run for 1000m on a track and field (randomly with and without the ball in separate sessions) at 80% of the VO_{2max} speed.

The speed will be monitored from an electronic photocell each 15m.

Fig. 2 - Path of linear running (LR)

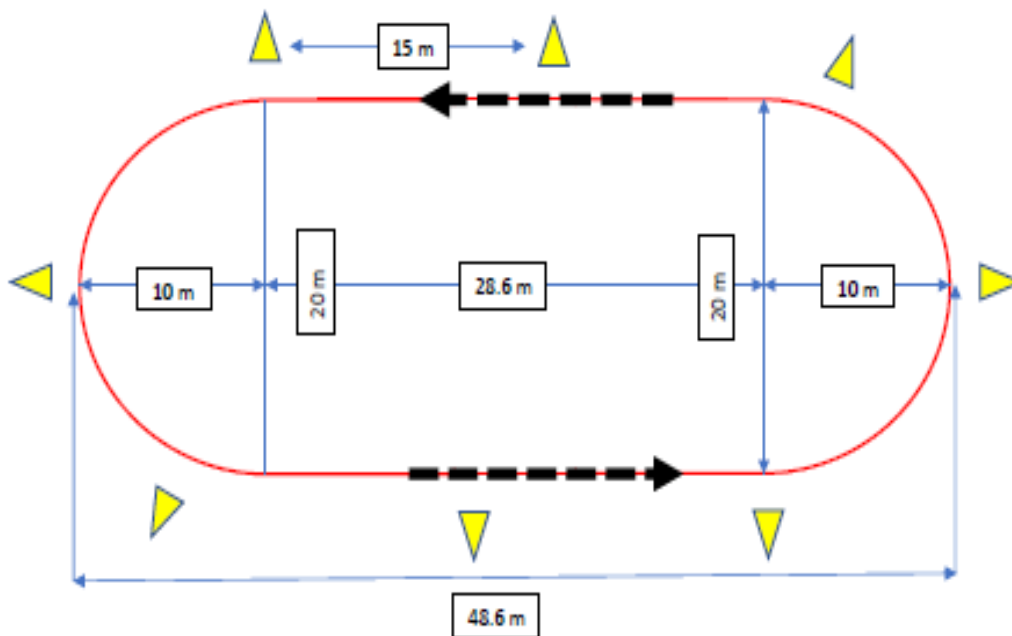

B) Shuttle run with changes of direction (180°)

The path SR (Figure 3) foresees that the players must run, back and forth between 2 yellow cones over a 15m distance, for 1000m at 80% of the VO₂max speed on a track and field (randomly with and without the ball in separate sessions).

The beep means that the players must change direction of 180° between two cones. The speed will be monitored from an electronic photocell each 15m.

Fig. 3 - Shuttle run (SR) with change of direction (180°)

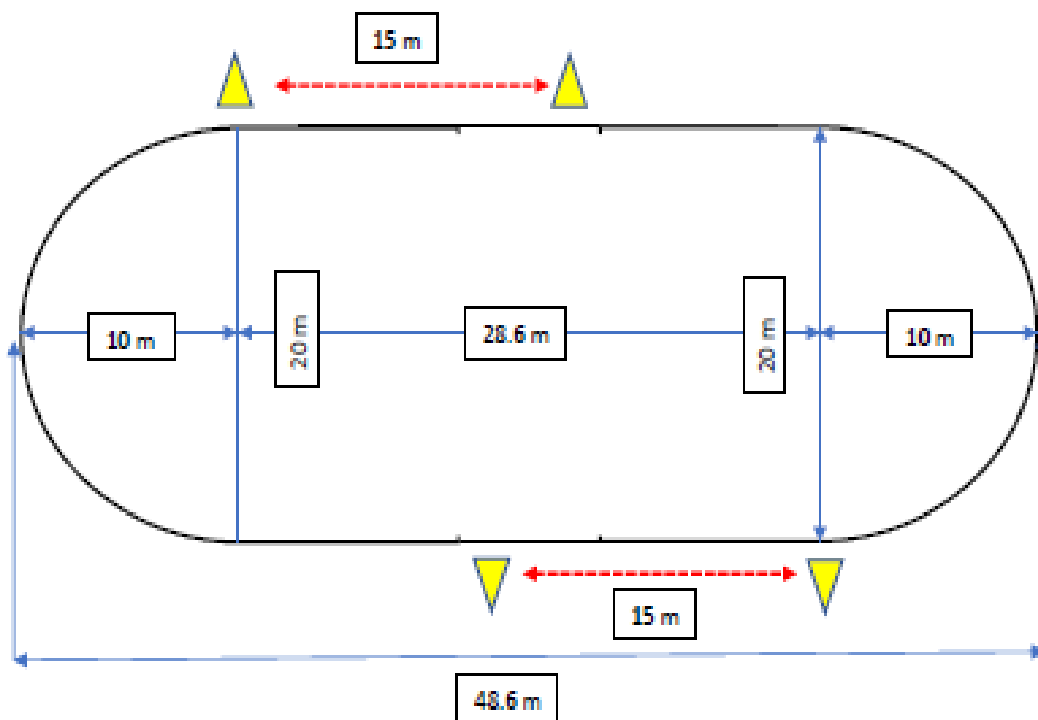

C) Linear running with stop and restart each 15m

The path LR & SSR (Figure 4) the players must run for 1000m at 80% of the VO₂max speed on a track and field (randomly with and without the ball in separate sessions).

The players must come to stop and restart at every 15m for 1sec, marked by yellow cones (without changes of direction). The speed is monitored from an electronic photocell each 15m.

Fig. 4 - Linear running with stop and restart every 15m (LR with SSR)

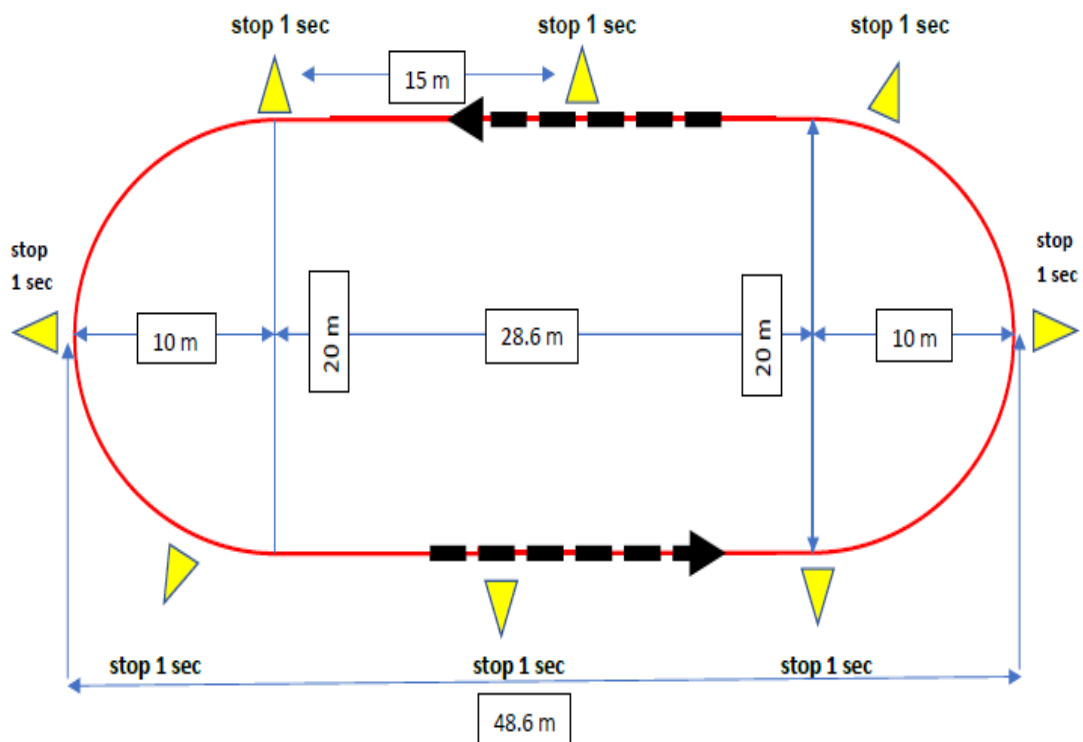

VO₂ and HR were simultaneously measured by a portable metabolic system (Metabolimeter K4b2) for each running conditions. The metabolic system was calibrated before each test.

Global Navigation Satellite System with inertial measurement unit will be fixed on body trunk to assess the body inclinations and Accelerations/Decelerations for each running task.

All participants need kept the pace within less than 1 m from the track marker, at each beep, and in relation to heart rate, detected by a frequency meter. After each running condition (30' minutes after) Ratings of Perceived Exertion will take for each player (Impellizzeri et al, 2004).

3.2 YO-YO Endurance Test

The Yo-Yo test is a test which in an easy way evaluates various aspects of performance in fast and simple manner. The test result is determined as the distance covered during the test.

Using the Yo-Yo test, it is possible to obtain information about a large number of athletes within a short time and have higher performance validity during competition than laboratory test (Bangsbo et al, 2006). The test is used to assess VO_2 max indirectly and with a good approximation.

The players run like a Yo-Yo back and forth between the markers at given speeds that are controlled by the CD.

The test consists of making the shuttle, running between two lines placed at a distance of 20 m from each other, at a rhythm marked by an acoustic signal.

The subject starts to run for 20 meters when he listens the first sound signal: the running speed should be such that the subject reaches the indication of the 20 meters at the exact moment when he hears the acoustic signal; therefore, making a change of direction at 180° (Figure 5). The subject will return to the starting point in time with the next signal.

The path is repeated until the subject is no longer able to maintain the rhythm currently imposed by the acoustic signal; the speed of the test, in fact, is increased regularly about every minute and the time elapsing between the two signals is obviously progressively reduced.

Fig. 5 - Yo-Yo Endurance test

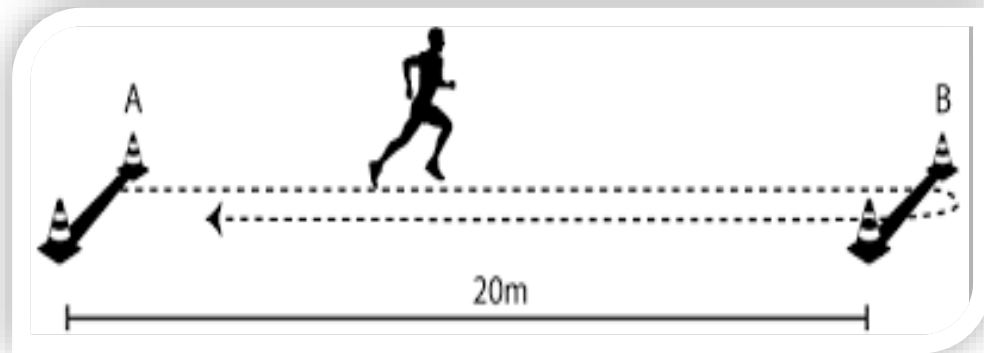

The test begins with a predetermined speed of 8 km/h for the beginner version (level 1) and 11.5 km/h for expert athletes (level 2).

The test ends when you are no longer able to execute the rhythm dictated by the acoustic signal for two successive steps: when the subject stops, the last speed and the number of shuttles covered at this speed are recorded, including the last one.

Scientific studies have shown (Bangsbo et al, 2006) a relationship between the results obtained with the yo-yo endurance test and the subjects' maximum oxygen consumption ($VO_2\text{max}$ expressed in $ml \cdot kg \cdot min^{-1}$).

So, the results obtained with the yo-yo endurance test provide a good indirect measure of a subject's maximum oxygen consumption, both for level 1 and level 2 of the test.

Table 2 can be used to convert the test results in terms of maximum oxygen consumption both for level 1 and 2 of test.

Table 2. VO₂max estimated from the field test

Speed : shuttle	VO ₂ max (ml·kg ⁻¹ ·min ⁻¹)	Speed : shuttle	VO ₂ max (ml·kg ⁻¹ ·min ⁻¹)	Speed : shuttle	VO ₂ max (ml·kg ⁻¹ ·min ⁻¹)
05:02	27.1	11:02	47.9	16:06	66.3
05:04	28	11:04	48.5	16:08	66.9
05:06	28.6	11:06	49.2	16:10	67.4
05:09	29.9	11:08	49.9	16:13	68.2
06:02	30.5	11:11	50.9	17:02	68.7
06:04	31.4	12:02	51.4	17:04	69.2
06:06	32.2	12:04	52	17:06	69.8
06:09	33.2	12:06	52.6	17:08	70.3
07:02	34	12:08	53.1	17:10	70.9
07:04	34.6	12:10	53.7	17:12	71.4
07:06	35.5	12:12	54.2	17:14	72
07:08	36.1	13:02	54.9	18:02	72.6
07:10	36.7	13:04	55.5	18:04	73.1
08:02	37.5	13:06	56	18:06	73.6
08:04	38.3	13:08	56.6	18:08	74.2
08:06	39.1	13:10	57.1	18:10	74.8
08:08	39.7	13:12	57.7	18:12	75.3
08:10	40.6	14:02	58.1	18:14	75.9
09:02	41.1	14:04	58.7	19:02	76.4
09:04	41.6	14:06	59.2	19:04	77
09:06	42.4	14:08	59.8	19:06	77.5
09:08	43	14:10	60.4	19:08	78.1
09:11	43.9	14:13	61.2	19:10	78.6
10:02	44.4	15:02	61.7	19:12	79.2
10:04	45	15:04	62.2	19:15	80
10:06	45.7	15:06	62.8	20:02	80.5
10:08	46.3	15:08	63.3	20:04	81.1
10:11	47.4	15:10	63.9	20:06	81.6
11:02	47.9	15:13	64.7	20:08	82.1
11:04	48.5	16:02	65.2	20:10	82.7
11:06	49.2	16:04	65.8		

Note: "Speed: shuttle" as example 05:02 mean that the subject has run at the speed of 05 km·h⁻¹ performed "02" twice (back and forward).

The average values of the variations found in elite runners (Table 3) who carried out level 2 of the test, according to research carried out by Jens Bangsbo and coll. (2006), are the following:

Table 3. Average values of the variations in elite runners (as example)

	Runners of elite
Average	18:2 (3621 m; 72.6 VO ₂ max)
Range	17:1 – 20.8 (3320 m - 4320 m) (68.7 – 82.1 VO ₂ max)

3.3 Shuttle and linear running

Shuttle runs can be used to study the physiological responses in sports (such as basketball) characterized by sprints (accelerations/decelerations) and changes of direction (Zamparo et al, 2014).

Shuttle runs are a type of intermittent exercise that can be used to study the physiological responses of these high-intensity activities, since these running conditions (with changes of direction, accelerations, and decelerations) are closer to those observed during a match than continuous running is.

However, the energy expenditure during a single shuttle run does not reach a steady state and thus cannot be easily determined; the studies on this topic are indeed limited and refer essentially to shuttles of 10 to 20 m and to changes of direction of 180° (Zadro et al, 2011; Buglione et al, 2013).

Instead, the linear running foresees a running continuous on a track. In our study foresees a path of 1000m of linear running (randomly with and without the ball in separate sessions) at 80% of the VO_2 max speed.

3.4 Lower limbs muscle strength (Ergojump Bosco System)

A vertical jump represents an activity of ballistic motion, and the maximal explosive power has been recorded utilizing a force-platform technique (Bosco & Komi 1979). The vertical jumping power and capacity of human can be evaluated according to the approximation of kinematic laws by measuring the flight time of consecutive vertical jumps during a certain time period. The flight time could be measured with a recently developed electronic apparatus (Bosco et al, 1983) called "Ergojump".

Ergojump Bosco System is used for the indirect evaluation of dynamic-explosive strength, explosive strength and alattacid anaerobic power by calculating the vertical displacement of the center of gravity with the Bosco method (Bosco et al, 1994).

With this test we measure the height reached by performing jumps with different techniques. Each test is characterized by the execution of three jumps: for the statistical survey the best result is considered.

The execution of the jumps is done using a conductivity platform connected to a microprocessor (Ergojump Bosco System).

The athletes perform a series of jumps that provide data subsequently processed by a software program that calculates contact and flight times in milliseconds, heights in centimeters and power in Watts.

In this study we used only one test of the battery of tests elaborated by Bosco: Squat Jump (SJ). The Squat Jump (SJ) will be performed to verify the muscle strength decrement.

During the execution the test, Squat Jump (SJ), the athlete performs a vertical jump starting from a position with lower limbs bent at 90° with the hands on the hips, without performing any counter-movement downwards.

The Squat-Jump allows to evaluate the explosive strength of the lower limbs: the elevation value is in relation to the vertical speed at the time of detachment. The main information is expressed in centimeters by the microprocessor.

3.5 Statistical analysis

All data are presented as mean and standard deviation (Mean±SD). Intra-class correlation coefficient (Hopkins, 2000) was calculated to assess the reliability of the measures for each running condition. Prior to the parametric analysis, the normality of data distribution was verified by the using Shapiro-Wilk test. Regarding energetic cost, between-subjects the t-test was used six times (for each running condition separately) to examine significance of differences for each running condition (n=6) while homogeneity of variances was checked with Levene's test.

Regarding lower limbs strength, the two-way 2×2 between-within ANOVA was used six times (for each running condition separately) to examine significance the main effect of the between-subjects factor *Group* (Guards and Forwards/Centers), within-subjects factor *Treatment* (Pre and Post) together with the factorial interaction *Group*×*Treatment*. The Bonferroni post-hoc correction was applied to identify particular differences. Partial eta squared (η^2) was used as a measure of the effect size.

Type I error was set at $\alpha=5\%$ and all statistical analyses were performed with the software IBM SPSS Statistics 23.

4. Devices

The method of detection and analysis of data requested the use of the following devices:

a) Metabolimeter K4b2 (Cosmed, Italy), allows to measure or recalculate the metabolic parameters starting from the consumption of oxygen (O_2), the production of carbon dioxide (CO_2) and heart rate, recalculating the respiratory quotient (QR) and the gross energy cost (C).

b) Optojump (Microgate, Italy), provides real-time data on contact time, flight time, step length and step frequency with no impedance to the athlete. This system consists of two parallel bars (one receiver and one transmitter unit) that transmit an infrared light 1 to 2 mm above the floor, allowing for athlete-surface interaction.

c) Ratings of Perceived Exertion (RPE), session RPE is a simple, reliable, not invasive, and valid method based on the Borg's category ratio 10 (CR 10) scale (Borg, 1982). The athlete rates the intensity of the session using the CR-10, and this value is multiplied by the session duration to get a training load (TL) score for the session. These session load values are used to calculate 2 other variables-training monotony and training strain.

d) GNSS-IMU (SpinItalia, Italy), presents both good validity and reliability for assessment of distance and speed in some linear displacements (Barbero-Álvarez et al, 2010) and during team sport simulated motion activity.

4.1 Metabolimeter

The use of Metabolimeter K4b2 (Cosmed, Italia) allows to measure or recalculate the metabolic parameters starting from the consumption of oxygen (O_2), the production of carbon dioxide (CO_2) and heart rate, recalculating the respiratory quotient (QR) and the gross energy cost (C).

All expected measurements are described below:

- FC: expressed in beats / min, it calculates the average of the measurements made by the heart rate monitor, for every minute of the tests.
- VO_2 : expressed in ml/kg/min, it calculates the average of the measurements made for every minute of the tests.
- C: expressed in J/kg/m, converting the VO_2 into Joule ($\times 20.93$) and the km/h in m/min ($\times 16,6666$), calculated as an average for each minute of the tests.

Figure 6. Portable Metabolimeter



The portable Metabolimeter is a new generation device and represents the most popular metabolic system in the world for field and laboratory tests (Figure 6). It allows the evaluation of gaseous exchanges (O_2/CO_2) during motor tasks such as running and is for years the most used and preferred device by the world scientific community in the field of sports physiology and applied research.

The K4b2 portable Metabolimeter is a portable ergospirometric system with "breath by breath" evaluation of cardiorespiratory function during exercise. The extreme versatility of the system allows the execution of tests in the laboratory and in the field in three different modes: holter data, telemetry transmission and laboratory system.

And thanks to a series of innovative functions and its compact design, it represents a huge step forward in the field of physiology and in the evaluation of physical performance in sport.

4.2 Optojump

Many biomechanical parameters may be sensitive to variations in velocity, including step length and step frequency (Dugan & Bhat, 2005). This has given rise to biomechanical systems such as Optojump that provides real-time data on contact time, flight time, step length and step frequency with no impedance to the athlete (Lehance et al, 2005).

This system is easy to set-up and consists of two parallel bars (one receiver and one transmitter unit) that transmit an infrared light 1 to 2 mm above the floor, allowing for athlete-surface interaction (Bosquet et al, 2009; Glatthorn et al., 2011).

Contemporary biomechanical systems such as Optojump (Figure 7) are often preferred during training due to their unobtrusive nature and ability to provide real-time information to inform the coaching process.

Scientific literature has demonstrated the reliability of the Optojump system in quantifying jump height derived from flight time during hopping and jumping (ICCs ranging between 0.982-0.989) and running reporting a coefficient of variation (CV) of 3% (Glatthorn et al., 2011).

As of yet no research has provided a comprehensive breakdown of how Optojump compares to video for contact time, flight time, step length, step frequency and velocity. Therefore, the measurement of agreement for Optojump and video must be established, without those biomechanical parameters quantified from one biomechanical system cannot be compared to the other (e.g. training data captured by Optojump cannot be compared to competition data captured by high-speed video).

Fig. 7 – Optojump (Microgate, Italy)



4.3 Ratings of perceived exertion (RPE)

Training for success is a balance between achieving peak performance and avoiding the negative consequences of excessive training. Training volumes and intensities that are not optimal do not have the desired physiological adaptations, whereas those that are excessive increase injury risk and impair sporting performance.

An appropriate periodization of the training stimulus applied to a player is important to obtain optimal sporting performance (Altavilla & Raiola, 2018).

A method for quantifying the training stimuli is the session rating of perceived exertion (session RPE) method developed by Foster et al. (2001).

Session RPE is a simple, reliable, not invasive, and valid method based on the Borg's category ratio 10 (CR 10) scale (Borg, 1982).

The athlete rates the intensity of the session using the CR-10, and this value is multiplied by the session duration to get a training load (TL) score for the session. These session load values are used to calculate 2 other variables-training monotony and training strain.

Research has shown that the session RPE method is a reliable and simple tool to assess TL in steady-state aerobic training (Foster et al, 1995), intermittent-aerobic training (Foster et al, 2001), and strength training (Day et al, 2004).

Explanation of the session RPE method:

The session RPE method monitors training by examining simple markers of both training volume and training intensity (Foster et al, 1996; 2001) developed the session RPE method based on a RPE for a session and the duration of the session.

By using these 2 variables, both the volume (duration) and the intensity (RPE) are factored into this method of monitoring.

To calculate the measure of session intensity, the player is asked to rate the intensity of the session 30 minutes after completion of the session (Foster et al, 2001). This is undertaken by asking them ‘How was your workout?’ and having them rate it against a modified rating of Borg’s CR-10 that can be seen in table 4.

Table 4. The session RPE scale

Rating	Descriptor
0	Rest
1	Very, very easy
2	Easy
3	Moderate
4	Somewhat hard
5	Hard
6	
7	Very hard
8	
9	
10	Maximal

Instructions and indications for the perception of exertion:

- 0 means "no effort" and 10 means "extremely strong-max" that is the maximum effort he has previously experienced.
- 1 corresponds to "very light" exercise. For a normal and healthy person it is like walking slowly at his pace for several minutes
- on the scale it is a "moderate" exercise. It is not that hard, everything is fine and there is no problem in continuing the exercise
- 5 corresponds to a "fairly hard" exercise. It is tiring and you feel tired, but there are still no major difficulties to continue.
- 7 is "very hard" is really tiring. A healthy person can continue but must make a lot of effort. Level 7 usually corresponds to 85% of the maximum heart rate, i.e. the percentage to which the ANAEROBIC THRESHOLD usually corresponds.
- 10 on the scale is an extremely tiring exercise level.

What is important for the athlete is his feeling of commitment and effort, not the comparison with other athletes. What people think is not important: otherwise, this scale, for the organization of work, would become a limit and not an advantage.

The delay in asking the player to rate the intensity of the session is done to ensure that the rating reflects the global intensity of the session (Foster et al, 2001).

If the rating was taken immediately postsession, a particularly difficult or easy section at the end of the session could dominate the player's rating.

The RPE should reflect a single global rating of the intensity for the entire training session. This RPE is then used in conjunction with the entire duration of the session to calculate the session TL. It is calculated by multiplying the session RPE by the session duration (Figure 8).

Fig. 8 - Training load is the product of session time and session RPE

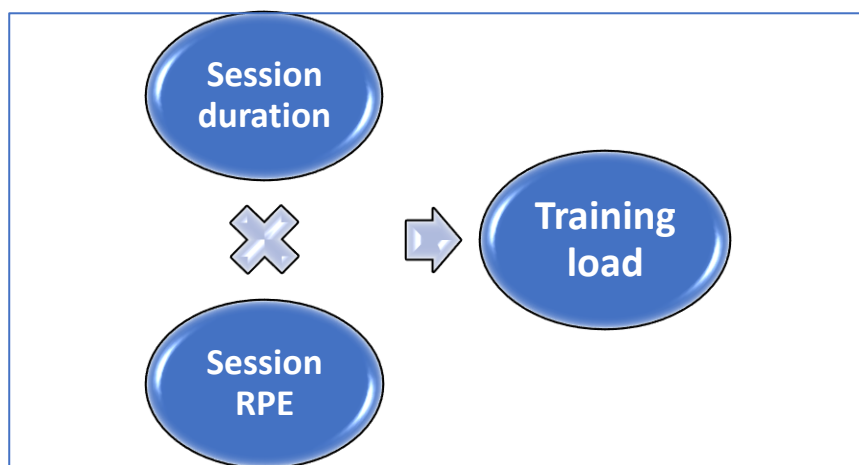

For example, if a basketball training session lasted 90 minutes in length and the player gave a RPE of 5 (hard) for the session intensity, then the following is the calculation of the TL for that session:

$$TL = 90 \times 5 = 450 \text{ arbitrary units (AU)}$$

By recording the session duration and session RPE (Carey et al, 2016) for each session during a typical training week and calculating each individual session TL, 2 important monitoring variables can be derived-training monotony and training strain. To accurately calculate these variables, each session load should be calculated and rest days calculated with a TL value of 0.

The quantification of the internal TL is also necessary to analyze the periodization of the training. In team sports, the appropriate periodization of the internal TL during the training week is important to ensure that adequate physiological stimulus is provided, while still allowing adequate recovery time before competition days.

4.4 Global navigation satellite system with inertial measurement unit (GNSS-IMU)

Global navigation satellite system receivers (GNSSrs) have become a common tool to assess players' physical activity during competition and training in team sports (Aughey, 2011). Coaches have preferred use of GNSSrs over other tracking techniques (e.g. video analysis) thanks to its time efficiency and real-time feedback (Scott et al, 2016).

GNSSr presents both good validity and reliability for assessment of distance and speed in some linear displacements (Barbero-Álvarez et al, 2010) and during team sport simulated motion activity (Portas et al, 2010).

Several studies showed that a GNSSr's reliability decreases when measuring distance and average/instantaneous speed during tasks requiring high-speed change of direction (Duffield et al, 2010; Jennings et al, 2010; Bloomfield et al, 2007).

Such tasks are common in team sports, with players frequently changing direction and stopping/starting (Brughelli et al, 2008). Ability to change direction is a required skill, as well as a key factor of success. Athletes may perform ~600 turning movements per match and more than half of all sprints (~3 s) involve at least one change.

Each player will be equipped with a 50-Hz 167-channel GNSSr receiving signals only from GNSS GPS (Spin_GNSS_50Hz, Spinitalia S.r.l., Pomezia, Italy), while each run time will be recorded using a photocell gate (Brower Timing System, Salt Lake City, UT, USA; accuracy of 0.01 s) connected by means of an external connector to a 100-Hz chronograph (Delta E200, Hanhart, Gütenbach, Germany) set to GPS time for GNSSr continuous signal synchronization.

Each participant will be asked to complete as fast as possible previously measured paths in order to evaluate GNSSr assessment accuracy in match play-like conditions. For test-retest reliability assessment, each player will be assessed on two different days while performing multiple-changes of direction runs.

5. Results

5.1 Anthropometric and physiological characteristics

All data are presented as mean and standard deviation (\pm SD). The Shapiro-Wilk test showed no significant deviation of data from the normal distribution.

Table 5 presents the principal anthropometric and physiological characteristics of subjects.

The mean age of the first group G (Guards) was 18.5 ± 0.2 years, the body height was 180.4 ± 2.8 cm, the body weight was 75.3 ± 2.5 kg, the body mass index was 23.1 kg/m^2 and indicated a normal value. The mean VO_2 max was 56.2 ± 1.9 and the heart rate max of 182.7 ± 2.7 .

Participants from the second group F/C (Forwards/Centres) were 18.7 ± 0.2 years old, their body height was 190.2 ± 3.1 cm, the body weight was 84.5 ± 3.1 kg, the body mass index was 23.3 kg/m^2 and indicated a normal value. The mean VO_2 max was 50.3 ± 2.3 and the heart rate max was 185.2 ± 2.5 .

Table 5. Anthropometric and physiological characteristics (mean \pm SD, n=30)

Variables	All subjects (n=30)	Guards (n=15)	Forwards/Centres (n=15)
Age (years)	18.6 \pm 0.2	18.5 \pm 0.2	18.7 \pm 0.2
Height (cm)	186.2 \pm 5.7	180.4 \pm 2.8	190.2 \pm 3.1
Weight (kg)	80.0 \pm 5.4	75.3 \pm 2.5	84.5 \pm 3.1
BMI (kg/m ²)	23.2	23.1	23.3
VO ₂ max (ml·kg ⁻¹ ·min ⁻¹)	53.4 \pm 4.6	56.2 \pm 1.9	50.3 \pm 2.3
Heart rate max (b/min)	183.9 \pm 8.2	182.7 \pm 2.7	185.2 \pm 2.5

Table 6. Physiological characteristics (mean \pm SD, n=30)

Variables	All subjects min	(n=30) max
Gross VO ₂ (ml·kg ⁻¹ ·min ⁻¹)	33.4 \pm 3.5	56.4 \pm 4.2
Heart rate (b·min ⁻¹)	141.3 \pm 9.1	186.3 \pm 7.5

Gross VO₂ between 33.4 \pm 3.5 and 56.4 \pm 4.2 (ml·kg⁻¹·min⁻¹), HR between 141 \pm 9.1 and 186.3 \pm 7.5 (b·min⁻¹) were detected (table 6). The group (G) both in the running conditions with and without ball has shown energetic costs and heart rates less values than the group (F/C); while has shown gross VO₂ and VO₂max more values than the group (F/C).

5.2 Energetic cost of running at six different conditions

T-test was used on two independent samples was to determine if there were any significant differences in the energetic cost for each running condition (n=6) between the two groups (Guards n=15; Forwards/Centres n=15) with the ball and without the ball.

The energetic cost (C) shown in table 7 demonstrates significant differences regarding both two groups analysed (Group G = Guards; Group F/C = Forwards/Centres) depending on each running conditions: LR without the ball with $p=0.010$; SR without the ball with LR & SR without the ball with $p=0.047$; $p=0.011$; LR with the ball with $p=0.024$; LR & SR with the ball with $p=0.013$ and SR with the ball with $p=0.008$. The homogeneity of the variance was checked by the use of Levene's test and it confirmed the homogeneity in all the conditions.

Table 7. The T-test for independent samples: the energetic cost for each running condition (n=6) between the two groups (G and F/C)

Variables	Mean G	Mean F/C	t-value	df	p	Levene's test F(1,df)	p Levene's test
Condition 1 energetic cost	4.80 ± 0.16	4.98 ± 0.20	-2,77	28	0.010	0.605	0.443
Condition 2 energetic cost	5.02 ± 0.26	5.25 ± 0.34	-2,07	28	0.047	2.348	0.137
Condition 3 energetic cost	5.21 ± 0.30	5.49 ± 0.27	-2,73	28	0.011	0.459	0.504
Condition 4 energetic cost	5.63 ± 0.23	5.82 ± 0.21	-2,39	28	0.024	0.009	0.926
Condition 5 energetic cost	6.02 ± 0.31	6.38 ± 0.43	-2,66	28	0.013	3.199	0.085
Condition 6 energetic cost	6.40 ± 0.41	6.80 ± 0.35	-2,86	28	0.008	0.596	0.447

In the figures 9 and 10 are shown the two compared groups' values for each running condition (with and without ball). The difference of the energetic cost is more evident between the two groups in the Shuttle Run with ball (G=6.40 and F/C=6.80 with $p=0.008$) and without ball (G=5.21 and F/C=5.49 with $p=0.011$).

Fig. 9 – Energetic cost of running without ball between two groups

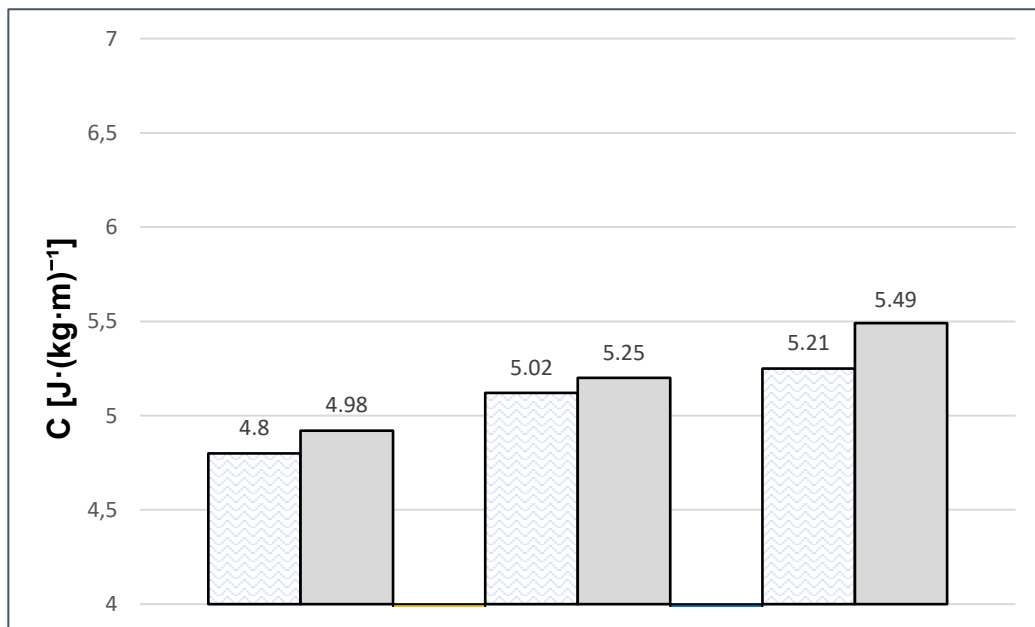

G= Guards; F/C= Forwards/Centres; LR&SR= Linear running & stop restart; LR= Linear running; SR= Shuttle run.

Fig. 10 – Energetic cost of running with ball between two groups

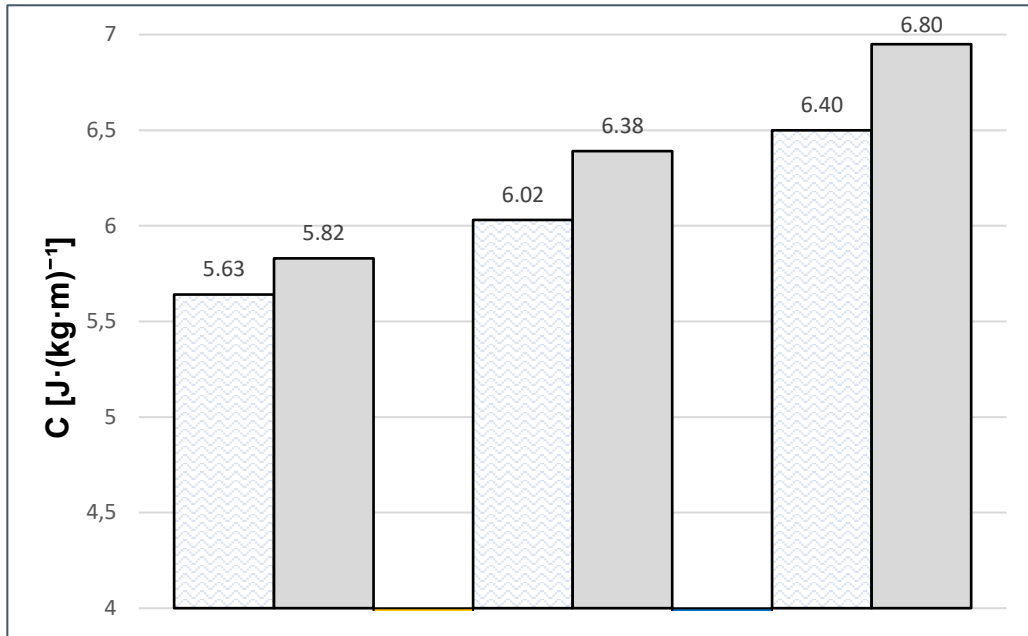

G= Guards; F/C= Forwards/Centres; LR&SR= Linear running & stop restart; LR= Linear running; SR= Shuttle run.

5.3 ICC for the reliability of the measures

Table 8 shows the values of Intraclass Correlation Coefficient (ICC) regarding the energetic cost detected after each running conditions for both groups: guards (G) and forwards/centres (F/C) with and without the ball. The ICC coefficient between the series of measurements of the energetic cost, in different running's conditions, was found to be excellent. The results showed fair to high reliability.

Table 8. ICC for the reliability of the measures of Energetic Cost

Running conditions	ICC (G)	ICC (F/C)
LR without the ball	0.98	0.97
LR&SR without the ball	0.94	0.96
SR without the ball	0.96	0.94
LR with the ball	0.96	0.97
LR&SR with the ball	0.97	0.98
SR with the ball	0.97	0.96

5.4 Lower limbs strength

All data are presented as mean and standard deviation (\pm SD). Shapiro-Wilk test showed that the data do not deviate significantly from the normal distribution, Levene’s test has verified the homogeneity of variance.

The following tables and figures illustrate the main effects and the interactions between two factors (Treatment-Groups) and the dependent variable (lower limb strength), for each running condition (pre and post) and for both groups (Guards and Forwards/Centres) detected through a two-way repeated measures ANOVA.

Table 9. Two way (between-within) 2x2 ANOVA: Condition 1

Effect	Degr. of freedom	F	P	Partial eta-squared
Groups	1	6	0.017	0.186
Error	28			
R1	1	81	0.000	0.743
R1*Groups	1	1	0.245	0.048
Error	28			

Table 9 shows the primary effects between groups, treatments and the interaction between treatment and groups through the use of two way (between-within) 2x2 Anova. There were significant differences between the two groups ($p = 0.017$) and in the treatments ($p = 0.000$) for the first running condition (Linear Running without ball); while the interaction between groups and treatments is not significant ($p = 0.245$). The size of the partial effect in the case of the groups is small (0.186) while in the case of the treatments it is large (0.743).

Fig.11 – Mean values together with 95% confidence interval for both groups and for both measurements

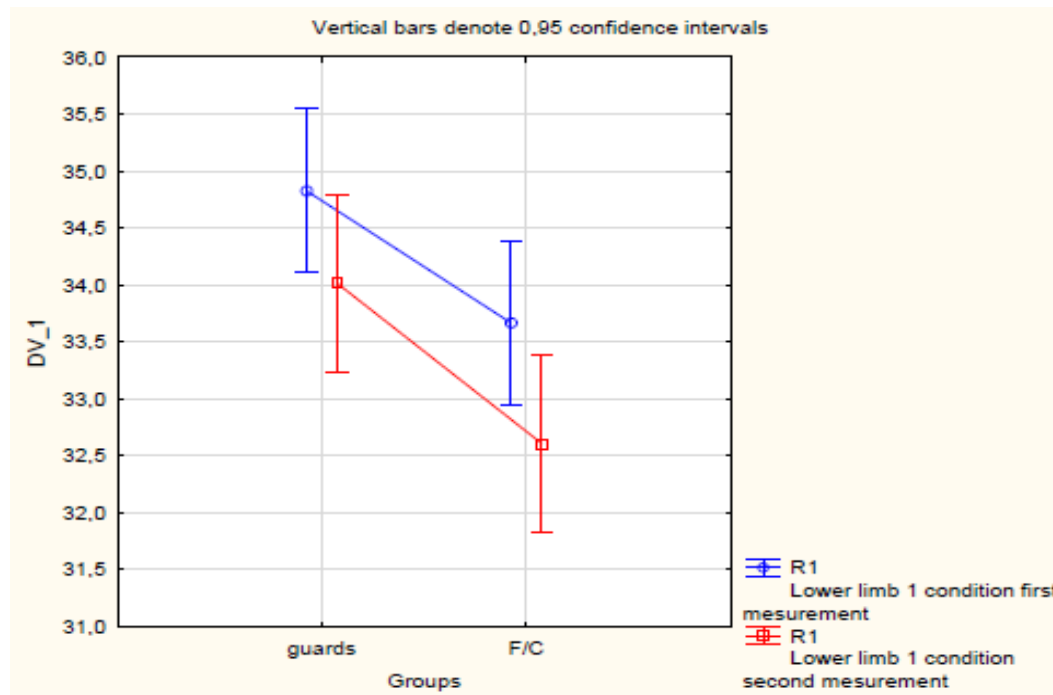

Figure 11 shows the effects before and after treatment, at two different times, for two groups G (Guards) and F/C (Forwards/Centres). There is a tendency to significance between the strength measurements of the lower limbs (pre and post – between two groups) in first running conditions (Linear Running without ball).

Table 10. Post hoc of interaction effects

Groups		R1	{1}	{2}	{3}	{4}
			34,825	34,013	33,665	32,607
1	Guards	Lower limb 1 condition first measurement		0.000	0.197	0.001
2	Guards	Lower limb 1 condition second measurement	0.000		1.000	0.065
3	F/C	Lower limb 1 condition first measurement	0.197	1.000		0.000
4	F/C	Lower limb 1 condition second measurement	0.001	0.065	0.000	

Table 10 shows the results of the interactions between groups and treatments (pre and post) through the Bonferroni post hoc test analysis. There is a significant difference between the first and second treatment, both for the Guards group and for the Forwards/Centers group (0.000), in the first running condition (Linear Running without the ball).

Table 11. Two way (between-within) 2x2 ANOVA: Condition 2

Effect	Degr. of freedom	F	p	Partial eta-squared
Groups	1	12.74	0.001	0.312
Error	28			
R1	1	25.88	0.000	0.480
R1*Groups	1	0.95	0.337	0.032
Error	28			

Table 11 shows the primary effects between groups, treatments and the interaction between treatment and groups through the use of two way (between-within) 2x2 Anova. There were significant differences between the two groups ($p = 0.001$) and in the treatments ($p = 0.000$) for the second running condition (Linear Running & Stop Restart without ball); while the interaction between groups and treatments is not significant ($p = 0.337$). The size of the partial effect in the case of groups is medium (0.312) as well as in the case of treatments (0.480).

Fig.12 – Mean values together with 95% confidence interval for both groups and for both measurements

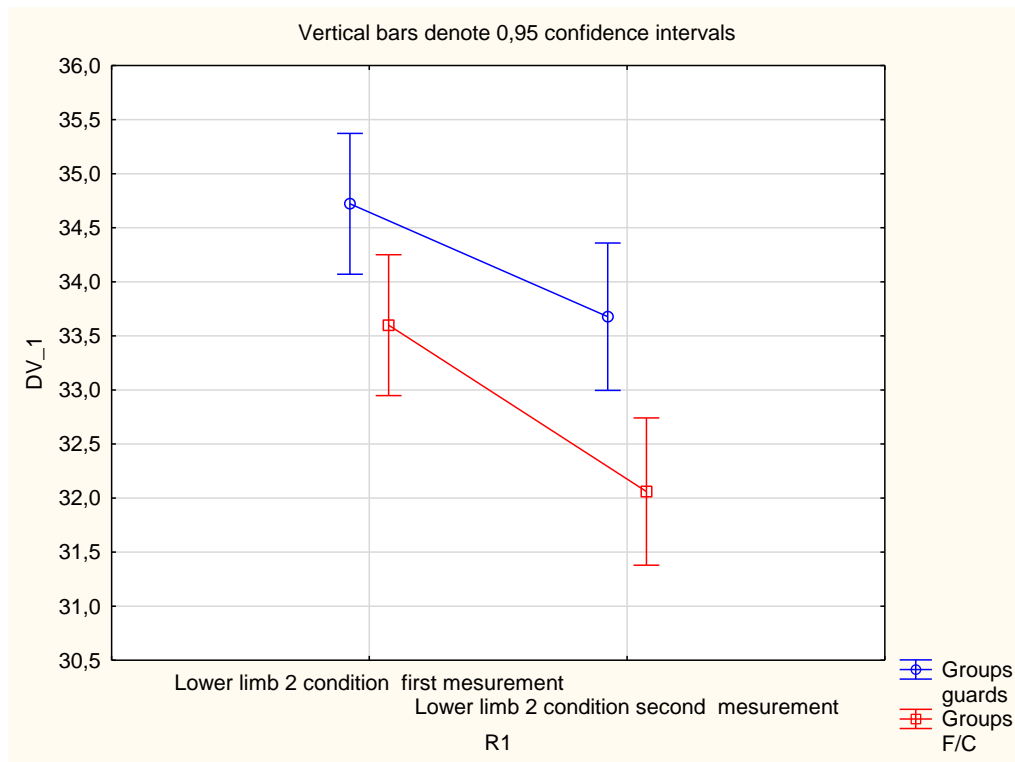

Figure 12 shows the effects before and after treatment, at two different times, for two groups G (Guards) and F/C (Forwards/Centres). There is a tendence to significancy between the strength measurements of the lower limbs (pre and post – between two groups) in second running conditions (Linear Running & Stop Restart without ball).

Table 12. Post hoc of interaction effects

Groups		R1	{1} 34,721	{2} 33,677	{3} 33,599	{4} 32,060
1	Guards	Lower limb 2 condition first measurement		0.042	0.111	0.000
2	Guards	Lower limb 2 condition second measurement	0.042		1.000	0.006
3	F/C	Lower limb 2 condition first measurement	0.111	1.000		0.001
4	F/C	Lower limb 2 condition second measurement	0.000	0.006	0.001	

Table 12 shows the results of the interactions between groups and treatments (pre and post) through the Bonferroni post hoc test analysis. There is a significant difference between the first and second treatment, both for the Guards group (0.042) and for the Forwards/Centers group (0.001), in the second running condition (Linear Running & Stop Restart without ball).

Table 13. Two way (between-within) 2x2 ANOVA: Condition 3

Effect	Degr. of freedom	F	p	Partial eta-squared
Groups	1	15.84	0.000	0.361
Error	28			
R1	1	31.51	0.000	0.529
R1*Groups	1	2.57	0.120	0.084
Error	28			

Table 13 shows the primary effects between groups, treatments and the interaction between treatment and groups through the use of two way (between-within) 2x2 Anova. There were significant differences between the two groups ($p = 0.000$) and in the treatments ($p = 0.000$) for the third running condition (Shuttle Run without ball); while the interaction between groups and treatments is not significant ($p = 0.120$). The size of the partial effect in the case of groups is medium (0.361) as well as in the case of treatments (0.529).

Fig.13 – Mean values together with 95% confidence interval for both groups and for both measurements

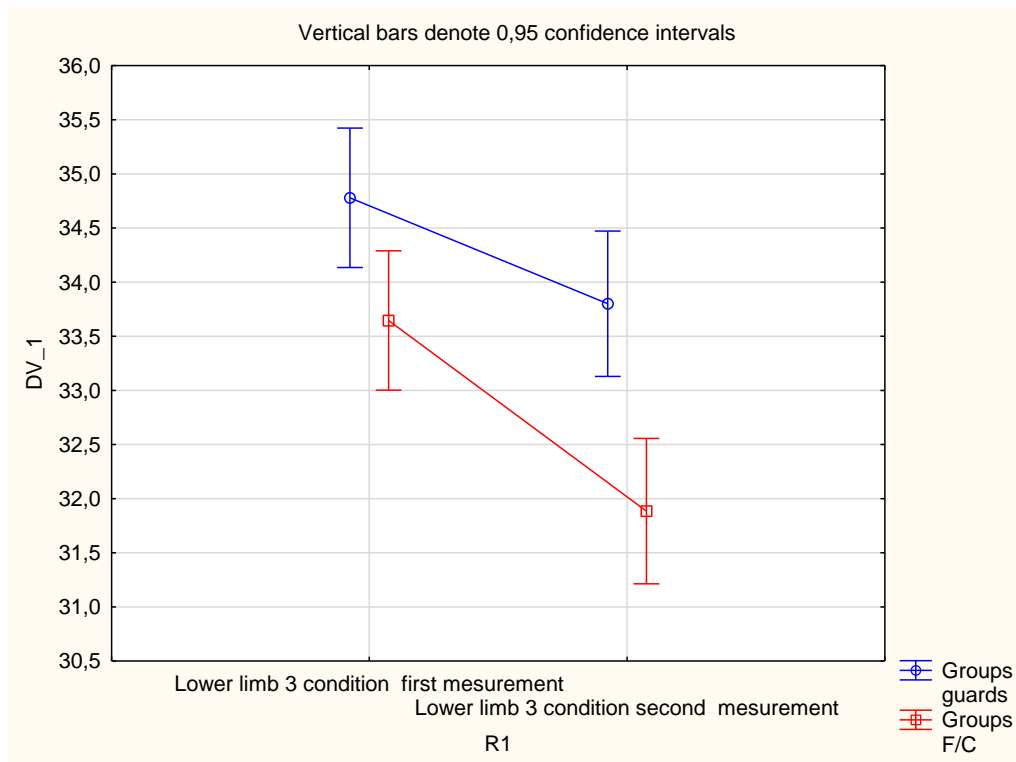

Figure 13 shows the effects before and after treatment, at two different times, for two groups G (Guards) and F/C (Forwards/Centres). There is a tendence to significancy between the strength measurements of the lower limbs (pre and post – between two groups) in third running conditions (Shuttle Run without ball).

Table 14. Post hoc of interaction effects

Groups		R1	{1} 34,779	{2} 33,801	{3} 33,646	{4} 31,885
1	Guards	Lower limb 3 condition first measurement		0.049	0.096	0.000
2	Guards	Lower limb 3 condition second measurement	0.049		1.000	0.000
3	F/C	Lower limb 3 condition first measurement	0.096	1.000		0.000
4	F/C	Lower limb 3 condition second measurement	0.000	0.000	0.000	

Table 14 shows the results of the interactions between the groups and the treatments (pre and post) through the Bonferroni post hoc test analysis. There is a significant difference between the first and second treatment both for the Guards group (0.049) and for the Forwards / Centers group (0.000) in the third running condition (Shuttle Run without ball).

Table 15. Two way (between-within) 2x2 ANOVA: Condition 4

Effect	Degr. of freedom	F	p	Partial eta-squared
Groups	1	6.47	0.016	0.187
Error	28			
R1	1	229.84	0.000	0.891
R1*Groups	1	1.01	0.324	0.034
Error	28			

Table 15 shows the primary effects between groups, treatments and the interaction between treatment and groups through the use of two way (between-within) 2x2 Anova. There are significant differences between the two groups ($p = 0.016$) and in the treatments ($p = 0.000$) for the fourth running condition (Linear Running with ball); while the interaction between groups and treatments is not significant ($p = 0.324$). The size of the partial effect in the case of groups is small (0.187), while it is large in the case of treatments (0.891).

Fig.14 – Mean values together with 95% confidence interval for both groups and for both measurements

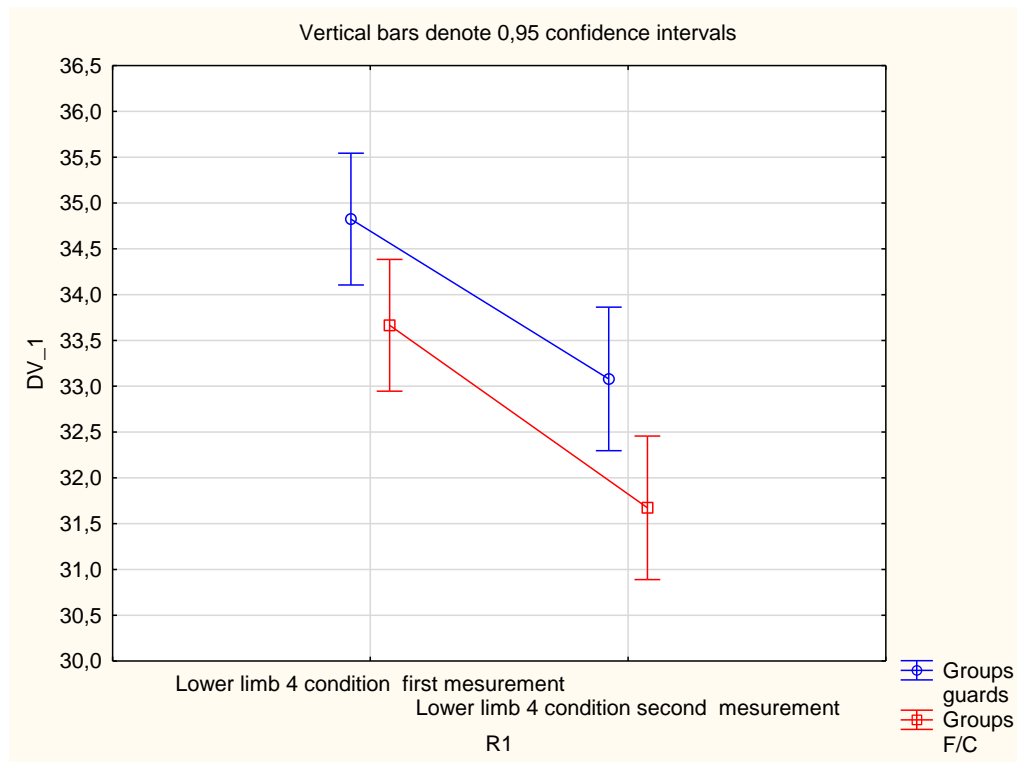

Figure 14 shows the effects before and after treatment, at two different times, for two groups G (Guards) and F/C (Forwards/Centres). There is a tendence to significancy between the strength measurements of the lower limbs (pre and post – between two groups) in fourth running conditions (Linear Running with ball).

Table 16. Post hoc of interaction effects

Groups		R1	{1}	{2}	{3}	{4}
			34,825	33,080	33,665	31,673
1	Guards	Lower limb 4 condition first measurement		0.000	0.197	0.000
2	Guards	Lower limb 4 condition second measurement	0.000		1.000	0.065
3	F/C	Lower limb 4 condition first measurement	0.197	1.000		0.000
4	F/C	Lower limb 4 condition second measurement	0.000	0.065	0.000	

Table 16 shows the results of the interactions between groups and treatments (pre and post) through the Bonferroni post hoc test analysis. There is a significant difference between the first and second treatment both for the Guards group (0.000) and for the Forwards/Centers group (0.000) in the fourth running condition (Linear Running with ball).

Table 17. Two way (between-within) 2x2 ANOVA: Condition 5

Effect	Degr. of freedom	F	p	Partial eta-squared
Groups	1	14.59	0.000	0.342
Error	28			
R1	1	81.26	0.000	0.743
R1*Groups	1	1.19	0.285	0.040
Error	28			

Table 17 shows the primary effects between groups, treatments and the interaction between treatment and groups through the use of two way (between-within) 2x2 Anova. There were significant differences between the two groups ($p = 0.000$) and in the treatments ($p = 0.000$) for the fifth running condition (Linear Running & Stop Restart with ball); while the interaction between groups and treatments is not significant ($p = 0.285$). The size of the partial effect in the case of the groups is medium (0.342), while it is large in the treatments (0.743).

Fig.15 – Mean values together with 95% confidence interval for both groups and for both measurements

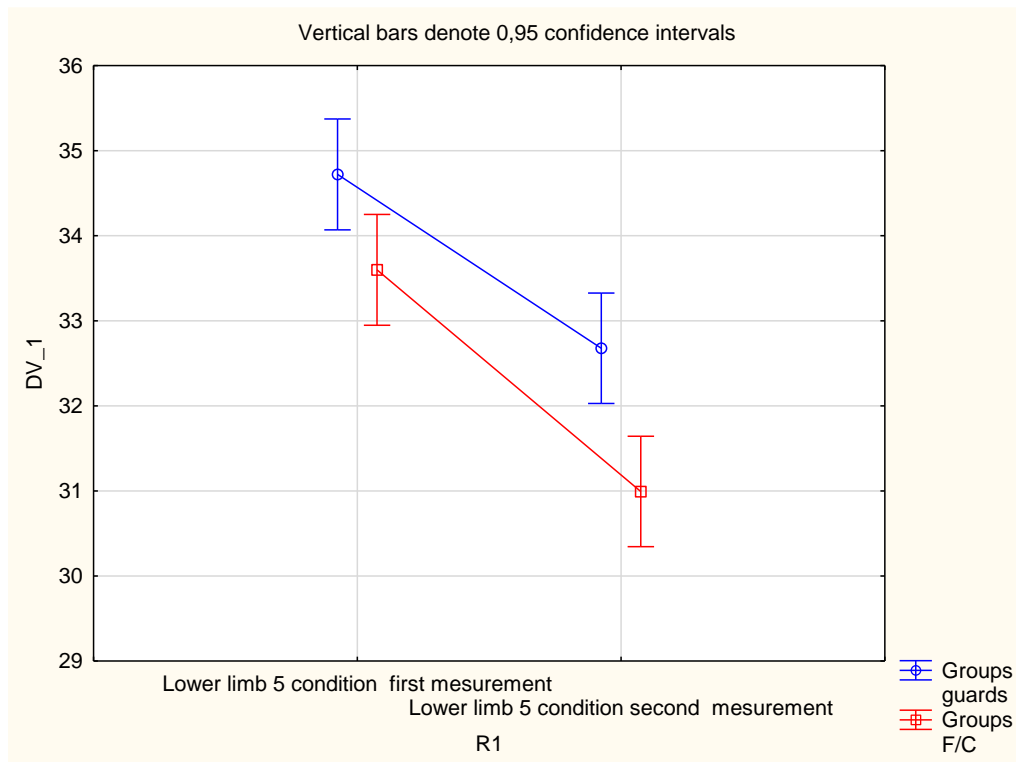

Figure 15 shows the effects before and after treatment, at two different times, for two groups G (Guards) and F/C (Forwards/Centres). There is a tendency to significance between the strength measurements of the lower limbs (pre and post – between two groups) in fifth running conditions (Linear Running & Stop Restart with ball).

Table 18. Post hoc of interaction effects

Groups		R1	{1} 34,721	{2} 32,677	{3} 33,599	{4} 30,993
1	Guards	Lower limb 5 condition first measurement		0.000	0.094	0.000
2	Guards	Lower limb 5 condition second measurement	0.000		0.271	0.002
3	F/C	Lower limb 5 condition first measurement	0.094	0.271		0.000
4	F/C	Lower limb 5 condition second measurement	0.000	0.002	0.000	

Table 18 shows the results of the interactions between groups and treatments (pre and post) through the Bonferroni post hoc test analysis. There is a significant difference between the first and second treatment both for the Guards group (0.000) and for the Forwards/Centers group (0.000) in the fifth running condition (Linear Running & Stop Restart with ball).

Table 19. Two way (between-within) 2x2 ANOVA: Condition 6

Effect	Degr. of freedom	F	p	Partial eta-squared
Groups	1	15.84	0.000	0.361
Error	28			
R1	1	94.31	0.000	0.771
R1*Groups	1	2.57	0.120	0.084
Error	28			

Table 19 shows the primary effects between groups, treatments and the interaction between treatment and groups through the use of two way (between-within) 2x2 Anova. There were significant differences between the two groups ($p = 0.000$) and in the treatments ($p = 0.000$) for the sixth running condition (Shuttle Run with ball); while the interaction between groups and treatments is not significant ($p = 0.120$). The size of the partial effect in the case of the groups is medium (0.361), while it is large in the treatments (0.771).

Fig.16 – Mean values together with 95% confidence interval for both groups and for both measurements

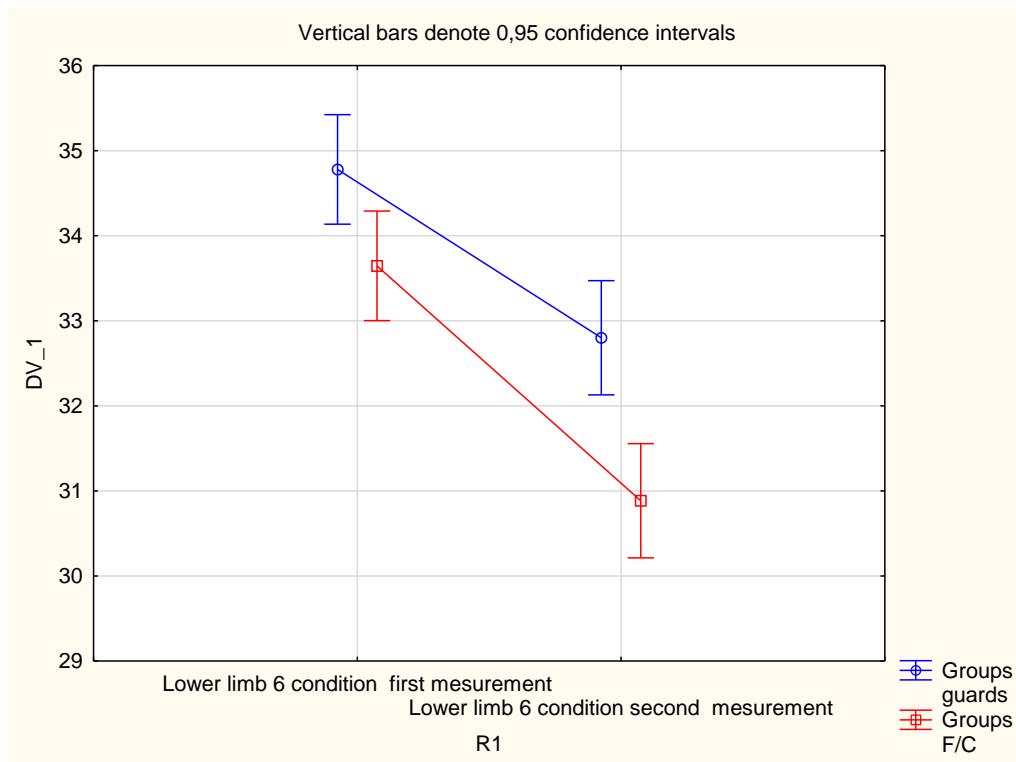

Figure 16 shows the effects before and after treatment, at two different times, for two groups G (Guards) and F/C (Forwards/Centres). There is a tendency to significance between the strength measurements of the lower limbs (pre and post – between two groups) in sixth running conditions (Shuttle Run with ball).

Table 20. Post hoc of interaction effects

Groups		R1	{1} 34,779	{2} 32,801	{3} 33,646	{4} 30,885
1	Guards	Lower limb 6 condition first measurement		0.000	0.096	0.000
2	Guards	Lower limb 6 condition second measurement	0.000		0.413	0.000
3	F/C	Lower limb 6 condition first measurement	0.096	0.413		0.000
4	F/C	Lower limb 6 condition second measurement	0.000	0.000	0.000	

Table 20 shows the results of the interactions between groups and treatments (pre and post) through the Bonferroni post hoc test analysis. There is a significant difference between the first and second treatment for both the Guards group (0.000) and for the Forwards/Centers group (0.000) in the sixth running condition (Shuttle Run with ball).

5.5 Values of RPE for each running condition

Table 21 shows the values of RPE detected after each running condition in both groups (Guards and Forwards/Centres). Participants have indicated their rating of perceived exertion (RPE, CR10-scale modified by Foster et al., 2001) immediately at the end of following six running conditions: Linear running without the ball, Linear running & stop and restart without the ball, Shuttle running without the ball, Linear running with the ball, Linear running & stop and restart with the ball and Shuttle running with the ball.

The results obtained by the use of the Student's t-test for paired groups, show that there are significant differences for each running condition and for both groups in terms of the training load (TL), with the exception of the linear running (LR) with the ball and without the ball ($p = 0.14$; $p = 0.07$).

Table 21. Value differences of RPE through the Student's t-test

Running conditions	Guards (n=15)		Forwards/Centres (n=15)		p
	RPE	RPE Session	RPE	RPE Session	
LR without the ball	3.27 ± 0.46	19.62	3.53 ± 0.52	21.18	0.14
LR&SR without the ball	3.73 ± 0.49	22.02	4.07 ± 0.46	23.22	0.04
SR without the ball	4.20 ± 0.41	24.78	4.60 ± 0.49	27.18	0.01
LR with the ball	4.13 ± 0.35	28.02	4.53 ± 0.52	29.58	0.07
LR&SR with the ball	4.93 ± 0.46	30.78	5.36 ± 0.49	33.18	0.01
SR with the ball	5.67 ± 0.41	34.80	6.20 ± 0.56	37.62	0.001

The results of the RPE, show in figure 17 and 18, have the similar trend of the differences detected in the different running modes between the two groups considered. Moreover, they have also confirmed that the increase of the RPE, during the Shuttle Run with ball, is due in addition to the contribution of the anaerobic mechanisms to the energy supply and motor control of the ball, but also to the perception of training stress, both physical and psychological.

Fig. 17 - RPE in different running conditions without ball between two groups

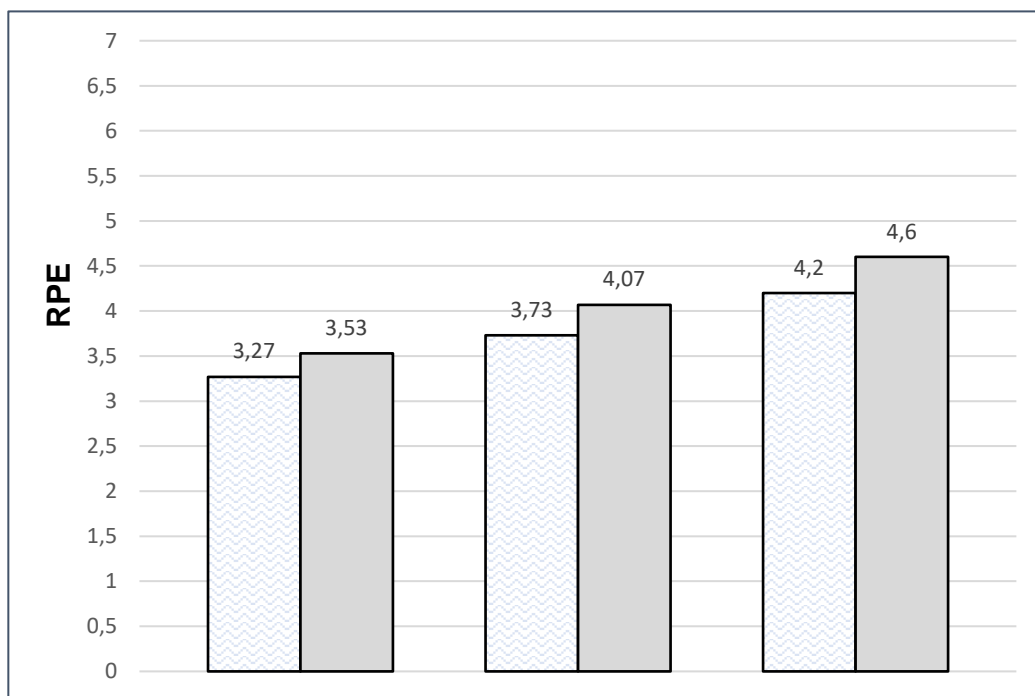

G= Guards; F/C= Forwards/Centres; LR= Linear running; LR&SR= Linear running & stop restart; SR= Shuttle run.

Fig. 18 - RPE in different running conditions with ball between two groups

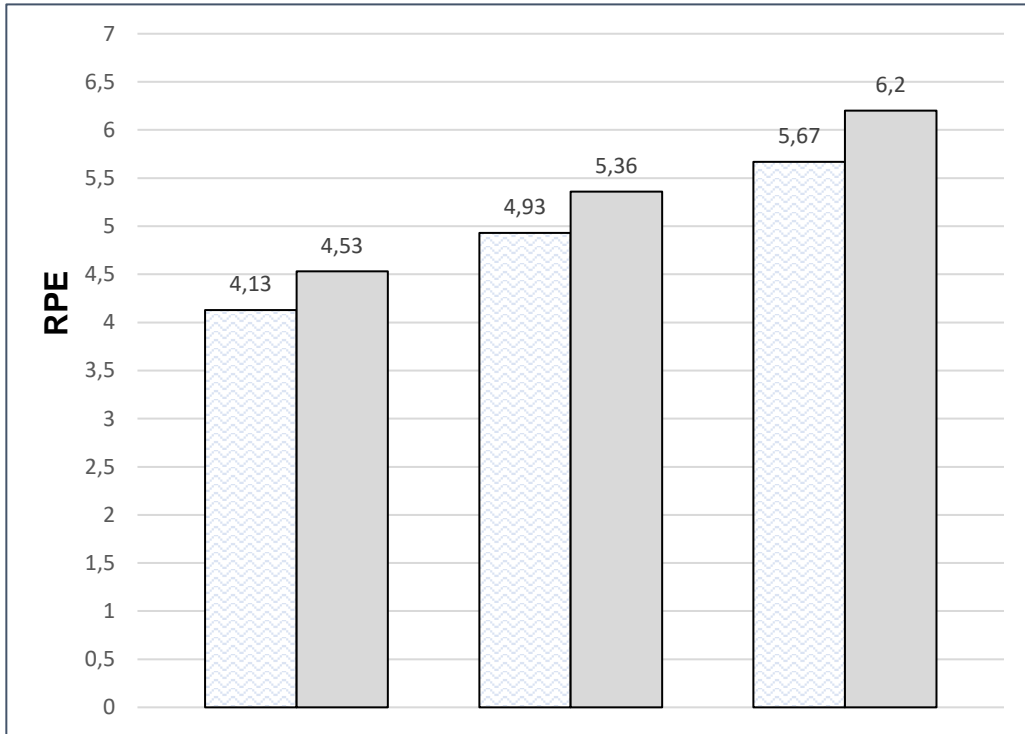

G= Guards; F/C= Forwards/Centres; LR= Linear running; LR&SR= Linear running & stop restart; SR= Shuttle run.

6. Discussion

6.1 Energetic cost in the running conditions and between the two groups

The aim of this study was to assess the differences of the energetic cost (C) between the positions basketball's players taken into consideration (Guards and Forwards/Centres) and between the different running conditions with and without ball: Linear Running (LR), Linear running with Stop and Restart (LR&SR) and Shuttle Run (SR) with 180° directional changes at specific speeds corresponding to 80% of the VO_2 max of each player.

In shuttle run (SR) the energetic cost (C) it is higher then linear running with stop and restart (LR&SR), and the energetic cost is even more then the linear running (LR), because stopping and restarting at certain speed require greater muscular and physiological effort.

The energetic cost, therefore, in the running with acceleration and deceleration (SR) result much more energetically expensive compared to the others two types of running. A more evident significant difference was detected between the two groups analyzed during SR with and without the ball, as it required a greater muscular work. This work is due to the action of stopping and restarting (table 7. $p=0.011$).

In the case of SR with the ball, it required even higher energetic demand due to the motor control of the ball (table 7. $p=0.008$). In addition to acceleration and decelerations of LR&SR, SR also implies directional changes, which may explain also why the extra VO_2 cost and HR response are slightly larger for SR than for LR&SR and LR.

Depending on speed and displacement modality, gross VO₂ between 33.4 ± 3.5 and 56.4 ± 4.2 ($\text{ml}\cdot\text{kg}^{-1}\cdot\text{min}^{-1}$), HR between 141.3 ± 9.1 and 186.3 ± 7.5 ($\text{b}\cdot\text{min}^{-1}$) were detected (table 6).

The group (G) in both running conditions with and without the ball showed rates of inferior values for the energetic cost and heart rate in respect to the group (F/C), whereas VO₂ and VO₂max resulted in higher values for the group (G).

This study offers new insights allowing a better understanding and a more accurate estimate of the energetic cost (C) associated with acceleration and deceleration, and changes in direction. Specifically, the results show that there is an increased energetic cost, VO₂ and Heart Rate response associated, above all, with the group F/C, when players change direction or dribble.

This investigation, therefore, is helpful in determining the energetic cost of intermittent sports and training, with and without changes in direction and with and without the ball.

6.2 Reliability of the measures (ICC)

The values of Intraclass Correlation Coefficient (ICC) estimated for the reliability of the measures of the energetic cost (C), for each running conditions in both groups (G and F/C) with and without the ball, were excellent showing a high reliability and ranging from 0.94 to 0.98, as shown in table 8.

In particular, the linear running without ball for the group of the guards the ICC has been estimated same to 0.98; whereas for the group of the forwards/centres the ICC has been estimated same to 0.97.

In the linear running with stop and restart without ball for the group of the guards the ICC has been estimated same to 0.94; whereas for the group of the forwards/centres the ICC has been estimated same to 0.96.

In the shuttle run without ball for the group of the guards the ICC has been estimated same to 0.96; whereas for the group of the forwards/centres the ICC has been estimated same to 0.94.

In the linear running with ball for the group of the guards the ICC has been estimated same to 0.96; whereas for the group of the forwards/centres the ICC has been estimated same to 0.97.

In the linear running with stop and restart with ball for the group of the guards the ICC has been estimated same to 0.97; whereas for the group of the forwards/centres the ICC has been estimated same to 0.98.

In the shuttle run with ball for the group of the guards the ICC has been estimated same to 0.97; whereas for the group of the forwards/centres the ICC has been estimated same to 0.96.

Finally, the values of Intraclass Correlation Coefficient between the series of measurements of the energetic cost detected after each running conditions in both

groups (Guards and Forwards/Centres), with and without the ball, it resulted being excellent showing a high reliability, indeed, they vary from 0.94 to 0.98

6.3 Lower limbs strength (pre and post)

Lower limbs muscle strength was assessed with Optojump (Microgate, Italy), before and after each running condition (LR, LR&SR, SR) with and without the ball, in both groups (G and F/C). With this statistic procedure each subject was measured twice, for each running condition and taking into consideration both groups.

Two-way repeated measures ANOVA has been used to show the significant differences (pre and post), the main effects and if there is an interaction between two factors (treatment and groups) on the dependent variable (lower limbs strength) detected with squat jump test.

When two-way repeated measures ANOVA is chosen to analyse the data this requires some assumptions to obtain valid results. Indeed, with Shapiro-Wilk test has been verified that the data do not deviate significantly from the normal distribution, then with Levene's test has been verified the homogeneity of variance.

The tables 9-11-13-15-17-19 show the main effects and interactions between two factors (Treatment-Groups) and the dependent variable (lower limbs strength), for each running condition (pre and post) and for the two groups (Guards and Forwards/Centres) detected through the two-way (between and within subjects factors) 2x2 ANOVA (n=6 conditions).

In all running condition there were significant differences between the two groups (Groups: 0.017; 0.001;0.000; 0.016; 0.000 and 0.000) and in the treatments (R1: 0.000; 0.000; 0.000; 0.000; 0.000 and 0.000). Therefore, for each running condition (n=6) there was a significant difference in strength decrement (lower limbs) both between the two groups and between the before and after the tests in each group. However the interactions between the groups and the treatment (R1*Groups) were not significant for all the running condition (p: 0.245; 0.337; 0.120; 0.324; 0.285; 0.120).

Figures 11-12-13-14-15-16 illustrate the main values together 95% confidence interval in both groups and in both measurements. These show the effects before and after treatment, at two different times, for two groups G (Guards) and F/C (Forwards/Centres). Therefore, for each running condition (n=6) there was a tendency to significance between the strength measurements of the lower limbs (pre and post – between two groups) in different running conditions.

Finally, the tables 10-12-14-16-18-20 show the interaction effects between groups and treatments (pre and post) through the Bonferroni post hoc test analysis. There was a significant difference between the first and second treatment, in both the Guards group and for the Forwards/Centers group, in different conditions: Guards= 0.000; 0.042; 0.049; 0.000; 0.000; 0.000 and Forwards/Centres= 0.000; 0.001; 0.000; 0.000; 0.000; 0.000.

6.4 RPE for each running condition and its utility

The method RPE was used for the rating of perceived exertion during the training. Session RPE is a simple, reliable, not invasive, and valid method based on the Borg's category ratio 10 (CR 10) scale (Borg, 1982).

In order to provide a valuable overall RPE score, the CR-10 scale was presented to the players two weeks before the start of the experimental period.

Then, during the experimental period, each player was asked about the perceived effort at the end of each running condition (LR, LR&SR and SR), about 30 minutes after, to evaluate the Training Load (TL), making him indicate the number on a sheet, not verbally, without knowing the indicated value by the other players, do it to see the others the indicated value, so as not to negatively influence the correct interpretation of the data.

The individual RPE scores from each session were multiplied by the duration of the test (minutes) to calculate the RPE and provide a meaningful analysis for comparisons between the two groups (table 21).

Indeed, between the two groups, in the linear running with and without ball, no significant difference has been detected ($p=0.14$ in LR without ball; $p=0.07$ in LR with ball); whereas in the other running conditions, namely in the linear running with stop and restart and in the shuttle run, with and without the ball, a significant difference has been detected between the two groups ($p=0.04$ in LR&SR without the ball; $p=0.01$ in LR&SR with the ball; $p=0.01$ in SR without the ball and $p=0.001$ in SR with the ball).

Coaches could take advantage of the use of this method, as it is very practical to monitor young people and avoid the need for expensive tools (hormonal tests, lactate analyzers, etc.).

The results of the RPE, show in figure 17 and 18, have the similar trend of the differences detected in the different running modes between the two groups considered.

Moreover, they have also confirmed that the increase of the RPE, during the Shuttle Run with and without the ball, is due in addition to the greater contribution of the anaerobic mechanisms to the energy supply and greater motor control of the ball, but also includes the perception of training stress, both physical and psychological.

The session RPE method can provide a valuable measure of the internal TL. Consequently, monitoring TL in youth basketball players is also critical to planning future appropriate training programs, which regularly tend to limit the occurrence of injuries, monotony, tension, overrun conditions and burnout and to examine the effects of specific strategies of periodization for the team in general and the player in particular.

The quantification of the internal TL is also necessary for the analysis of the periodization of the training.

During team sports, the appropriate periodization of the internal TL during the training week is important to ensure that adequate physiological stimulus is provided, provided that adequate recovery time before the competition days.

7. Conclusions

This study indicates that the energetic cost (C) for the shuttle running is greater than that for the linear run, (C) is also greater in the running with ball than in the running without the ball and is higher for the F/C group (forward/center) than group G (guards).

Furthermore, C is higher as much is higher the running speed and it is as larger as shorter the shuttle path, as also indicate by Buglione & di Prampero (2013), because of the cost of decelerations and accelerations imposes larger physiological demands on athletes compared to linear running at constant speed.

The main evidence of this study has confirmed my initial hypothesis, showing a different metabolic expenditure in the six running conditions (Linear Running, Linear Running & Stop and restart, Shuttle run with and without ball) and between the two groups taken in consideration (Guards and Forwards/Centres).

Indeed, the group (G) rather than the group (F/C) has obtained inferior values significant of C and HR, while major values of VO_2 in the different running conditions, with and without ball.

In addition, difference energy cost (C) between the two groups (G and F/C) increases even more during the running with the ball compared to running without the ball, independently of changes in direction.

This last point could be justified from an additional energetic request due to the conditioning of the motor control of the ball required to synchronize dribble during different running conditions of the tallest players (Forwards and Centres).

In any case, the energy consumption in different running conditions and between the two groups were significantly different. One of the reasons for the mentioned was that in linear running with stop and restart (LR&SR) every 15 m (with and without the ball) it was increased in relation to the deceleration/acceleration of the player on the frontal plane, as compared to the continuous linear running and this difference was even more prominent in the shuttle running with the changes in direction (with and without the ball).

Indeed, in this last condition, during the deceleration and acceleration phase, the player's body mass stabilization needed more mechanical work.

The results of this study could be useful for coaches not only to better understand the physiological requirements of team sports with frequent changes of direction, but also to better perceive the differences between using VO_2 consumption and HR monitoring in quantifying workloads during such activities.

Finally, coaches may find this information useful for planning their training sessions, to optimize the load of work in relation to the position and to energetic capacities of players.

To achieve this, it is necessary to act on the load, thus modifying and customizing it, in relation to different positions of players. For example, modifying the loads' variables such as time, speed, distance, recovery and the type of technical movement to be performed.

With reference to this last aspect, the technical movement should be very similar to that one of the match. This allows to optimize learning and motor control in young basketball players.

8. Pratical applications

According to the results acquired on the energetic cost, in the different running conditions and in different positions of the players, there is an even greater need to use specific exercises during training (exercises very similar to the actions performed during the match) with the purpose of improving the performance of basketball players, such as the energy cost, $VO_2\text{max}$, the ability to sustain workloads and high intensity in a prolonged manner, with frequent changes of direction and with short recovery periods.

An effective drill that can be used during training is an intermittent work, created by shuttles with short recovery times, accelerations and decelerations, with speed's variations, with and without changes of direction, with and without dribble.

This kind of work in the basketball results is very effective, just because the recovery time, how it happens during the basketball game, between an attack and defense action is not completely recovered.

9. References

- Altavilla, G., & Raiola, G. (2014). Global vision to understand the game situations in modern basketball. *Journal of Physical Education and Sport*, 14(4): 493-496.
- Altavilla, G., & Raiola, G. (2015). Sports game tactic in basketball, *Sport Science*, 8 (1): 43-46.
- Altavilla, G., & Raiola, G. (2018). Periodization: finalization of the training units and of the load's entity, *The European Proceedings of Social & Behavioural Sciences EpSBS*, eISSN: 2357-1330.
- Altavilla, G., & Raiola, G. (2019). A brief review on physiological commitment in basketball: an interpretative key. *Journal of Human Sport and Exercise*, 14(1proc): S59-S65.
- Altavilla, G. (2020). Energetic cost in the different running conditions in team sport for the educational teaching method, *Sport Science*, 14(1), 17-20.
- Argus, C.K., Gill, N.D., Keogh, J.W. (2012). Characterization of the differences in strength and power between different levels of competition in rugby union athletes. *Journal of Strength and Conditioning Research*, 26(10):2698–2704.
- Aughey, R.J. (2011). Applications of GPS technologies to field sports. *International Journal Sports Physiology Performance*, 6(3):295–310.
- Bangsbo, J., Mohr, M., Poulsen, A., Perez-Gomez, J., Krstrup, P. (2006). Training and testing the elite athlete, *Journal of Exercise Science and Fitness*, 4(1):1-14.
- Bangsbo, J. Yo-Yo Test. *Ancona: Kells*, 1996
- Bangsbo, J. Fitness Training in Football, a scientific approach *publisher August Krogh Institute - Copenhagen University (December 1994)*.
- Bangsbo, J. (1994). Energy demands in competitive soccer. *Journal of Sports Sciences*, 12:S5-S12.
- Barbero-Álvarez, JC, Coutts, A, Granda, J, Barbero-Álvarez, V, Castagna, C. (2010). The

- validity and reliability of a global positioning satellite system device to assess speed and repeated sprint ability (RSA) in athletes. *Journal of Science and Medicine in Sport*, 13(2):232–235).
- Bartlett, J.D., O'Connor, F., Pitchford, N., Torres-Ronda, L., Robertson, S.J. (2017). Relationships Between Internal and External Training Load in Team Sport Athletes: Evidence for an Individualised Approach, *International Journal of Sports Physiology and Performance*, 12(2):230-234.
- Bekraoui, N., Boussaidi, L., Cazorla G., Léger, L. (2018). Oxygen uptake, heart rate, and lactate responses for continuous forward running and stop-and-go running with and without directional changes. *Journal of Strength and Conditioning Research*, 00(00):1–9.
- Ben Abdelkrim, N., Castagna, C., El Fazaa, S., El Ati, J. (2010a). The effect of players' standard and tactical strategy on game demands in men's basketball. *Journal of Strength and Conditioning Research*, 24(10): 2652–2662.
- Ben Abdelkrim, N., Castagna, C., Jabri, I., Battikh, T., El Fazaa, S., El Ati J. (2010b). Activity profile and physiological requirements of junior basketball players in relation to aerobic-anaerobic fitness. *Journal of Strength and Conditioning Research*, 24:2330-2342.
- Ben Abdelkrim, N., El Fazaa, S., El Ati, J. (2007). Time-motion analysis and physiological data of elite under-19-year-old basketball players during competition, *British Journal of Sports Medicine*, 41(2):69-75.
- Bloomfield, J., Polman, R., O'Donoghue, P. (2007). Physical demands of different positions in FA Premier League soccer. *Journal of Sports Science & Medicine*, 6(1):63–70.
- Bisciotti, N., Sagnol, J., Filaire, E. (2000a). Bioenergetic aspects of fractional running in football. *SdS-Scuola dello Sport*, 50: 21–27.
- Bobbert, M.F., Gerritsen, K.G., Litjens, M.C., Van Soest, A.J. (1996). Why is countermovement jump height greater than squat jump height? *Medicine and Science in Sports and Exercise*, 28(11): 1402-1412.

- Bompa, T.O., & Haff, G.G. (2009). Periodization. Theory and Methodology of Training. *II: Human Kinetics*.
- Borg, G. (1982). Psychophysical basis of perceived exertion. *Medicine and Science in Sports and Exercise*, 14: 363–367.
- Bosco, C., Komi, P.V., Bosco, E., Nicol, C., Pulvirenti, G., Caruso, I. (1994). Influence of training on mechanical and biochemical profiles of athlete's muscles. *Coaching and Sport Science Journal*; 1(1): 8-13.
- Bosco, C., Luhtanen, P., Komi, PV (1983). A simple method for measurement of mechanical power in jumping. *European Journal of Applied Physiology*, 50(2):273-82.
- Bosco, C., & Komi, P.V. (1979). Mechanical characteristics and fiber composition of human leg extensor muscles. *European Journal of Applied Physiology* 41:275-284.
- Bosquet, L., Berryman, N., Dupuy, O. (2009). A comparison of 2 optical timing systems designed to measure flight time and contact time during jumping and hopping. *Journal of Strength and Conditioning Research*, 23(9): 2660-2665.
- Bourbousson, J., Seve, C., McGarry, T. (2010). Space-time coordination dynamics in basketball: Part 2. The interaction between the two teams. *Journal of Sports Sciences*, 28, 349:358.
- Brughelli M, Cronin J, Levin G, Chaouachi A. (2008). Understanding change of direction ability in sport. *Sports Medicine*, 38(12):1045–1063.
- Buglione, A., & di Prampero, P.E. (2013). The energy cost of shuttle running. *European Journal of Applied Physiology*, 113(6):1535–1543.
- Carey, D.L., Ong, K., Morris, M.E., Crow, J., Crossley, K. M. (2016). Predicting ratings of perceived exertion in Australian football players: methods for live estimation, *International Journal of Computer Science in Sport*, 15(2):64-77.
- Castagna, C., Abt, G., Manzi, V., Annino, G., Padua, E., D'Ottavio, S. (2008). Effect of recovery mode on repeated sprint ability in young basketball players, *Journal of Strength and Conditioning Research*, 22(3).

- Cavagna, G.A., Franzetti, A., Fuchimoto, T. (1983). The mechanism of walking in children, *The Journal of Physiology*, 343: 323-339.
- Cohen, J. (1988). *Statistical Power Analysis for the Behavioral Sciences*. New York, NY: Routledge Academic.
- Conley, D.L., Krahenbuhl, C.S. (1980). Running economy and distance running performance of highly trained athletes. *Medicine and Science in Sports Exercise* 12: 357-360.
- Cortis, C., Tessitore, A., Lupo, C., Pesce, C., Fossile, E., Figura, F. (2011). Inter-limb coordination, strength, jump, and sprint performances following a youth men's basketball game. *Journal of Strength and Conditioning Research*, 25: 135-142.
- Crisafulli, A, Melis, F, Tocco, F, Laconi, P, Lai, C, and Concu, A. (2002). External mechanical work versus oxidative energy consumption ratio during a basketball field test. *Journal of Sports Medicine and Physical Fitness*, 42: 409-417.
- Da Cruz-Ferreira, A.M., & Ribiero, C.A.F. (2013). Anthropometric and physiological profile of Portuguese rugby players - part I: comparison between athletes of different position groups. *Revista Brasileira de Medicina do Esporte*, 19(1): 48-51.
- Day, M., McGuigan, MR., Brice, G., Foster, C. (2004). Monitoring exercise intensity during resistance training using the session-RPE scale. *Journal of Strength and Conditioning Research*, 18: 353–358.
- Daniels, J.T., Yarbrough, R.A., Foster, C. (1978). Changes in VO₂ max and performance with training. *European Journal of Applied Physiology*, 39: 249-254.
- Dellal, A., Keller, D., Carling, C., Chaouachi, A., Wong, D.P., Chamari, K. (2010). Physiologic effects of directional changes in intermittent exercise in soccer players. *Journal of Strength and Conditioning Research*, 24(12): 3219-3226.

- Dežman, B. (2003). Differences in the number of offences and selective indicators of the playing efficiency of the national teams playing at the world championship for men in 1998 and 2002. *Trener*, 3 (1):67-70.
- di Prampero, P.E. (1986). The energy cost of human locomotion on land and in water, *International Journal of Sports Medicine*, 7(2): 55-72.
- di Prampero e Veicteinas. *Fisiologia dell'uomo*, edi ermes Milano, 2002.
- di Prampero, P.E., Fusi, S., Sepulcri, L., Morin, J.B., Belli, A. Antonutto, G. (2005). Sprint running: A new approach. *Journal of Experimental Biology*, 208:2809-2816.
- di Prampero, P.E., Salvadego, D., Fusi, S., Grassi, B. (2009). A simple method for assessing the energy cost of the running during incremental test, *Journal of Applied Physiology*, 107:1068-1075.
- di Prampero, P.E., Botter, A., Osgnach, C. (2014). The energy cost of sprint running and the role of metabolic power in setting top performances. *Eur J Appl Physiol.*, 115(3):451-469.
- Duffield, R., Reid, M., Baker, J., Spratford, W. (2010). Accuracy and reliability of GPS devices for measurement of movement patterns in confined spaces for court-based sports. *Journal of Science and Medicine in Sport*, 13(5):523–525.
- Dugan, S.A., & Bhat, K.P. (2005). Biomechanics and analysis of running gait. *Physical medicine and rehabilitation clinics of North America*, 16(3): 603-621.
- Foster, C., Florhaug, J.A., Franklin, J., Gottschall, L., Hrovatin, L., Parker, S., Doleshal, P., & Dodge, C. (2001). A new approach to monitoring exercise training. *Journal of Strength and Conditioning Research*, 15:109–115.
- Foster, C., Daines, E., Hector, L., Snyder, A., & Welsh, R. (1996). Athletic performance in relation to training load. *Wisconsin Medical Journal* 95: 370–374.
- Foster, C., Hector, L.L., Welsh, R., Schrager, M., Green, M.A., & Snyder, A.C. (1995). Effects of specific versus cross-training on running performance. *European Journal of Applied Physiology and Occupational Physiology* 70: 367–372.

- Foster, C., Costill, D.L., Daniels, J.T., Fink, W.J. (1978). Skeletal muscle enzyme activity, fiber composition and VO₂max in relation to distance running performance. *European Journal of Applied Physiology* 39: 73-80.
- Fox, E.L., & Costill, D.L. (1972). Estimated cardiorespiratory responses during marathon running. *Archives Environmental Health*, 24:315-324.
- Gaetano R., Rago, V. (2014). Preliminary study on effects of hiit-high intensity intermittent training in youth soccer players, *Journal of Physical Education and Sport*, 14 (2): 148-150.
- Glatthorn, J.F., Gouge, S., Nussbaumer, S., Stauffacher, S., Impellizzeri, F.M., Maffiuletti, N. (2011). Validity and reliability of optojump photoelectric cells for estimating vertical jump height. *The Journal of Strength & Conditioning Research*, 25(2), 556-560.
- Hall, C., Figueroa, A., Fernhall, B., Kanaley, J.A. (2004). Energy expenditure of walking and running: Comparison with prediction equations. *Medicine Sciences Sports Exercise* 36: 2128–2134.
- Hopkins, W.G. (2000). Measures of reliability in sports medicine and science, *Sports Medicine*, 30(1):1-15.
- Hoffman, J.R., & Maresh, C.M. (2000). Physiology of basketball. In: Garret WE, Kirkendall DT, eds. *Exercise and Sport Science*. Philadelphia, PA: Lippincott Williams & Williams.
- Kamandulis, S., Venckūnas, T., Masiulis, N., Matulaitis, K., Balčiūnas, M., Peters, D., & Skurvydas, A. (2013). Relationship between general and specific coordination in 8-to 17-year-old male basketball players. *Perceptual and Motor Skills*, 117(3): 821–836.
- Klusemann, MJ, Pyne, DB, Hopkins, WG, and Drinkwater, EJ. (2013). Activity profiles and demands of seasonal and tournament basketball competition. *International Journal of Sports Physiology and Performance*, 8: 623–629.
- Jeličić, M., Ivančev, V., Čular, D., Čović, N., Stojanović, E., Scanlan, AT., Milanović, Z. (2020). The 30-15 Intermittent Fitness Test: A Reliable, Valid, and Useful Tool

- to Assess Aerobic Capacity in Female Basketball Players. *Research Quarterly for Exercise and Sport*, 91(1), 83-91.
- Jennings, D., Cormack, S., Coutts, A.J., Boyd, L., Aughey, R.J. (2010). The validity and reliability of GPS units in team sport specific running patterns. *International Journal of Sports Physiology and Performance*, 5(3):328–341.
- Impellizzeri, F.M., Rampinini, E., Maffiuletti, N., Marcora, SM. (2007). A Vertical Jump Force Test for Assessing Bilateral Strength Asymmetry in Athletes, *Medicine & Science in Sports & Exercise*, 39(11): 2044-2050.
- Impellizzeri, F.M., Rampinini, E., Coutts, A.J., Sassi, A., Marcora, S.M. (2004). Use of RPE-Based Training Load in Soccer, *Medicine & Science in Sports & Exercise*, 36 (6): 1042-1047.
- Léger, L.A. & Gadoury, C. (1989). Validity of the 20 m shuttle run test with 1 min stages to predict VO_{2max} in adults. *Canadian Journal of Sport Sciences*, 14: 21–26.
- Léger, LA, Mercier, D, Gadoury, C, Lambert, J. (1988). The multistage 20 metre shuttle run test for aerobic fitness. *Journal of Sports Science* 6: 93–101.
- Léger, L. A. & Lambert, J. A. (1982). Maximal Multistage 20-m Shuttle Run Test to Predict VO_2 max, *European Journal of Applied Physiology* 49:1-12.
- Léger, L.A., & Boucher, R. (1980). An indirect continuous running multistage field test: The University of Montreal track test. *Canadian Journal of Sport Sciences*, 6:77–84.
- Lehance, C., Croisier, J.L., Bury, T. (2005). Optojump system efficiency in the assessment of lower limbs explosive strength. *Science and Sports*, 20(3):131-135.
- Lothian, F., & Farrally, M. (1995). A comparison of methods for estimating oxygen uptake during intermittent exercise. *Journal of Sports Sciences*, 13:491-497.
- Lucia, A., Esteve-Lanao, J., Oliván, J., Gómez-Gallego, F., San Juan, A.F., Santiago, C.,

- Foster, C. (2006). Physiological characteristics of the best Eritrean runners - exceptional running economy. *Applied Physiology, Nutrition and Metabolism* 31:530-540.
- Marcelino, P.R., Aoki, M.S., Arruda, A.F.S., Freitas, C.G., Mendez-Villanueva, A., Moreira, A. (2016). Does small-sided-games' court area influence metabolic, perceptual, and physical performance parameters of young elite basketball players? *Biology of Sport*, 33(1): 37-42.
- Margaria R. Fisiologia muscolare e meccanica del movimento. *Biblioteca Est Edizioni Scientifiche e Techiche Montadori Milano*, 1975.
- Margaria, R., Cerretelli, P., Aghemo, P., Sassi, G. (1963). Energy cost of running. *Journal of Applied Physiology*, 18: 367-370.
- Margaria, R. Sulla fisiologia, e specialmente sul consumo energetico della marcia a varie velocità ed inclinazioni del terreno. *Atti Associazione Nazionale Lincei*, 7: 299-368 (1938).
- McInnes, S.E., Carlson, J.S., Jones, C.J., McKenna, M.J. (1995). The physiological load imposed on basketball players during competition. *Journal of Sports Sciences*. 13(5): 387-97.
- Menier, D.R., & Pugh, L.G.G.E. (1968). The relation of oxygen intake and velocity in walking and running, in competition walkers. *The Journal of Physiology*, 197: 717-731.
- Minetti A.E., Capelli, C., Zamparo, P., di Prampero, P.E., Saibene, F. (1995). Effects of stride frequency on mechanical power and energy expenditure of walking. *Medicine & Science in Sports & Exercise* 27:1194-1202.
- Montgomery, P.G., Pyne, D.B., Minahan, C.L. (2010). The physical and physiological demands of basketball training and competition, *International Journal of Sports Physiology and Performance*, 5(1):75-86.
- Morgan, D.W., Bransford, D.R., Costill, D.L., Daniels, J.T., Howley, E.T., Krahenbuhl, G.S. (1995). Variation in the aerobic demand of running among trained and untrained subjects. *Medicine and Science in Sports and Exercise* 27: 404-409.

- Narazaki, K., Berg, K., Stergiou, N., Chen, B. (2009). Physiological demands of competitive basketball, *Scandinavian Journal of Medicine & Science in Sports*, 19: 425-432.
- Nikolaidis, P. T., Ingebrigtsen, J., Póvoas, S. C., Moss, S., Torres-Luque, G., & Pantelis, N. (2015). Physical and physiological characteristics in male team handball players by playing position - Does age matter? *Journal of Sports Medicine and Physical Fitness*, 55(4): 297-304.
- Oliveira, G.T., Gantois, P., Faro, H., Do Nascimento, P., Paes, P., Fortes, L., Batista, G. (2018). Vertical jump and handgrip strength in basketball athletes by playing position and performance. *Journal of Physical Education and Sport*, 18(1):132-137.
- Osgnach, C., Poser, S., Bernardini, R., Rinaldo, R., Di Prampero, P.E. (2010). Energy cost and metabolic power in elite soccer: A new match analysis approach. *Medicine and Science in Sports and Exercise*, 42: 170–178.
- Polglaze, T., Dawson, B., Butfield, A., Peeling, P. (2018). Metabolic power and energy expenditure in an international men's hockey tournament, *Journal of Sports Sciences*, 36(2):140-148.
- Portas, M.D., Harley, J.A., Barnes, C.A., Rush, C.J. (2010). The validity and reliability of 1-Hz and 5-Hz Global Positioning Systems for linear, multidirectional, and soccer-specific activities. *International Journal of Sports Physiology and Performance*, 5(4):448–458.
- Puente, C., Abian-Vicen, J., Areces, F., Lopez, R., Del Coso, J. (2017). Physical and physiological demand of experienced male basketball players during a competitive game, *Journal of Strength and Conditioning Research*, 31(4): 956-962.
- Sanchez-Sanchez, J., Carretero, M., Ramirez-Campillo, R., Petisco, C., Diego, M., Gonzalo-Skok, O., Nakamura, F.Y. (2018). Effects of high-intensity training with one versus three changes of direction on young female basketball player's performance. *Kinesiology* 50(Suppl.1):117-125.

- Scanlan, A., Dascombe, B., Reaburs, P.A. (2011). Comparison of the activity demands of elite and sub-elite Australian men's basketball competition. *Journal of Sports Sciences; 29(11):1153–1160.*
- Scanlan, A. T., Stojanović, E., Milanović, Z., Teramoto M., Jeličić, M., Dalbo, J. V. (2021). Aerobic capacity according to playing role and position in elite female basketball players using laboratory and field tests. *International Journal of Sports Physiology and Performance, 16(3):435-438.*
- Schot, P., Dart, J., Schuh, M. (1995). Biomechanical analysis of two changes of direction maneuvers while running. *Journal of Orthopaedic & Sports Physical Therapy, 22(6):254–258.*
- Scott, M.T.U., Scott, T.J.U., Kelly, V.G. (2016). The Validity and Reliability of Global Positioning Systems in Team Sport: A Brief Review. *Journal of Strength and Conditioning Research, 30(5):1470–1490.*
- Vaquera, A., Villa, J.G., Morante, J.C., Thomas, G., Renfree, A.J., Peters, D.M. (2016). Validity and test-retest reliability of the TIVRE-Basket Test for the determination of aerobic power in elite male basketball players, *Journal of Strength and Conditioning Research, 30(2): 584–587.*
- Zadro, I., Sepulcri, L., Lazzer, S., Fregolent, R., Zamparo, P. (2011). A protocol of intermittent exercise (shuttle runs) to train young basketball players. *Journal of Strength and Conditioning Research, 25(6): 1767-1773.*
- Zamparo, P., Zadro, I., Lazzer, S., Beato, M., Sepulcri, L. (2014). Energetics of shuttle runs: the effects of distance and change of direction, *International Journal of Sports Physiology and Performance; 9(6):1033-1039.*
- Williams, K.R., Cavanagh, P.R. (1987). Relationship between distance running mechanics, running economy, and performance. *Journal of Applied Physiology 63:1236-1245.*